

# GAL

# QUICK LOCATOR GUIDE

<b>Car Signal Components</b> .....	638-641
Battery .....	641
Emergency Lights .....	641
Emergency Stop Switch Assemblies .....	640-641
Fire Service Key Switches .....	638
Key Switches, Keys .....	638-639
Limit Switches .....	641
Position Indicators .....	640
Pushbutton Caps .....	640
Pushbutton Modules .....	640
<b>Coils</b> .....	644
<b>Contacts</b> .....	644-645
<b>Door Operators</b> .....	612-613
MOVFR .....	612
MOD, MODL Operators .....	613
<b>Door Parts And Equipment</b> .....	614-636
Arm & Roller .....	623-624
Bridging Cam .....	625, 627
Car Door Clutch, Clutch Kits, Links, Locking Assemblies .....	629-634
Clutch and Restrictor Parts, Cam, Links .....	633-636
Door Keys .....	619
Door Hanger Rollers, Wiper, Roller Kit .....	615-617
Door Contacts .....	623
Electric Eye Assembly Type T .....	615
Gate Switch, Contacts, Interlock Switch, Door Lock .....	621-624
Hanger and Track Assemblies .....	616-617
MO Jumper, Drive Pulleys, Cams, Bearing Block Assembly .....	625, 628
MOH/MOM Interlock .....	621-622
MOM Drive & Bearing Block, Limit Control, Clutch .....	628
Pick-Up Roller Assembly MOM & MOH Release .....	620-621
Reel Closer, Spirators and Mounting Bracket .....	619
Safety Edge Equipment, Type RA .....	614
Tension Pulley Assembly .....	620
<b>Motors</b> .....	637
<b>Printed Circuit Boards</b> .....	642-643
<b>Relay Parts</b> .....	646-647
<b>Selector Contact</b> .....	648
<b>Timers</b> .....	644
<b>Wheels And Rollers</b> .....	615, 648

## Door Operators

GAL

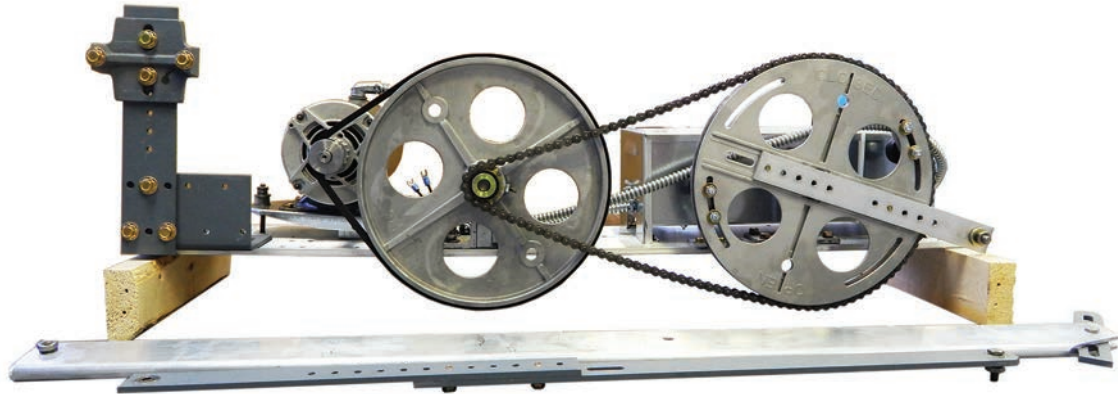

GDO-MOVFR-002R

S.E.E.S. #	O.E.M. #	Description
GDO-MOVFR-002L	OP99-0002L	Door Operator, L.H., MOVFR, Single Speed-2 Speed 25"-29", 208 VAC, 13" Hdr
GDO-MOVFR-002R	OP99-0002R	Door Operator, R.H., MOVFR, Single Speed-2 Speed 25"-29", 208 VAC, 13" Hdr
GDO-MOVFR-003L	OP99-0003L	Door Operator, L.H., MOVFR, Single Speed-2 Speed 30"-34", 208 VAC, 13" Hdr
GDO-MOVFR-003R	OP99-0003R	Door Operator, R.H., MOVFR, Single Speed-2 Speed 30"-34", 208 VAC, 13" Hdr
GDO-MOVFR-004L	OP99-0004L	Door Operator, L.H., MOVFR, Single Speed-2 Speed 35"-39", 208 VAC, 13" Hdr
GDO-MOVFR-004R	OP99-0004R	Door Operator, R.H., MOVFR, Single Speed-2 Speed 35"-39", 208 VAC, 13" Hdr
GDO-MOVFR-005L	OP99-0005L	Door Operator, L.H., MOVFR, Single Speed-2 Speed 40"-44", 208 VAC, 13" Hdr
GDO-MOVFR-005R	OP99-0005R	Door Operator, R.H., MOVFR, Single Speed-2 Speed 40"-44", 208 VAC, 13" Hdr
GDO-MOVFR-006L	OP99-0006L	Door Operator, L.H., MOVFR, Single Speed-2 Speed 45"-48", 208 VAC, 13" Hdr
GDO-MOVFR-006R	OP99-0006R	Door Operator, R.H., MOVFR, Single Speed-2 Speed 45"-48", 208 VAC, 13" Hdr
GDO-MOVFR-006L-A	OP99-0006L	Door Operator, LH, MOVFR, SS-2Spd 45-48", 115 VAC, Drive V

S.E.E.S. #	O.E.M. #	Description
GDO-MOVFR-200	OP101-0028N	Door Operator, MOVFR II 2SCP Special, with Door Drive Arm
GPC-201	MOVFR-0072N	Drive, 115 VAC for MOVFR II Oper Includes Drive Ribbon Cable

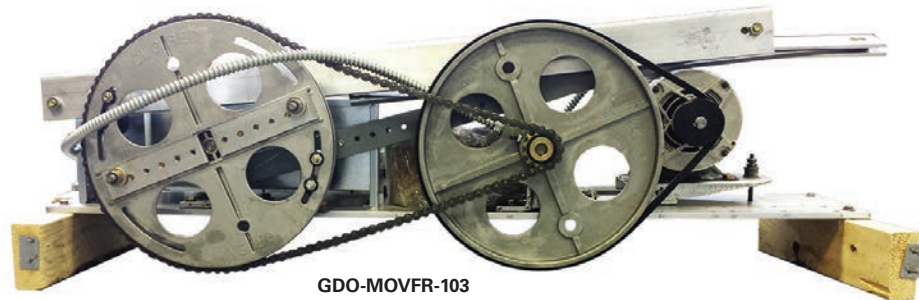

GDO-MOVFR-103

S.E.E.S. #	O.E.M. #	Description
GDO-MOVFR-101	OP100-0003N	Door Operator, CP, MOVFR, Single Speed-2 Speed, 30"-33" D.O., 208 VAC, 15" Hdr
GDO-MOVFR-102	OP100-0003N	Door Operator, CP, MOVFR, Single Speed-2 Speed, 34"-39" D.O., 208 VAC, 15" Hdr
GDO-MOVFR-103	OP100-0003N	Door Operator, CP, MOVFR, Single Speed-2 Speed, 40"-49" D.O., 208 VAC, 15" Hdr
GDO-MOVFR-104	OP100-0003N	Door Operator, CP, MOVFR, Single Speed-2 Speed, 50"-54" D.O., 208 VAC, 15" Hdr
GDO-MOVFR-105	OP100-0003N	Door Operator, CP, MOVFR, Single Speed-2 Speed, 55"-59" D.O., 208 VAC, 15" Hdr

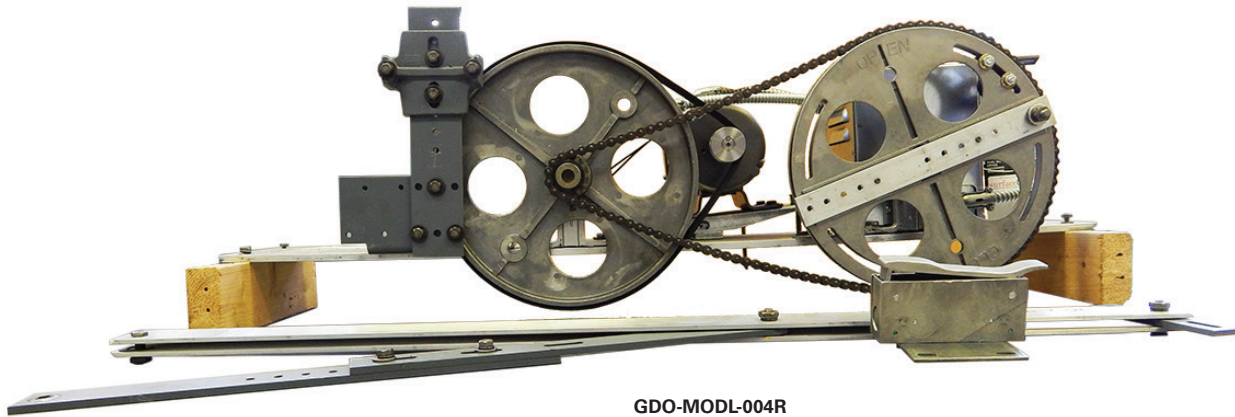

GDO-MODL-004R

S.E.E.S. #	O.E.M. #	Description
GDO-MODL-001L	OP1-0001L	<b>Door Operator</b> , L.H., MODL Single Speed 22-24" D.O. 220 VDC Motor, 13" Hdr
GDO-MODL-001R	OP1-0001R	<b>Door Operator</b> , R.H., MODL Single Speed 22-24" D.O. 220 VDC Motor, 13" Hdr
GDO-MODL-002L	OP1-0002L	<b>Door Operator</b> , L.H., MODL Single Speed 25-29" D.O. 220 VDC Motor, 13" Hdr
GDO-MODL-002R	OP1-0002R	<b>Door Operator</b> , R.H., MODL Single Spd 25-29" D.O. 220 VDC Motor, 13" Hdr
GDO-MODL-003L	OP1-0003L	<b>Door Operator</b> , L.H., MODL 2 Speed 24-29" D.O. 220 VDC Motor, 13" Header
GDO-MODL-003R	OP1-0003R	<b>Door Operator</b> , R.H., MODL 2 Speed 24-29" D.O. 220 VDC Motor, 13" Header
GDO-MODL-004L	OP1-0004L	<b>Door Operator</b> , L.H., MODL Single Speed-2 Speed 30-34" D.O. 220 VDC Motor, 13" Header
GDO-MODL-004R	OP1-0004R	<b>Door Operator</b> , R.H., MODL Single Speed-2 Speed 30-34" D.O. 220 VDC Motor, 13" Header
GDO-MODL-005L	OPI-0005L	<b>Door Operator</b> , L.H. MODL Single Speed-2 Speed 35-39" D.O. 220 VDC Motor, 13" Header
GDO-MODL-005R	OPI-0005R	<b>Door Operator</b> , R.H. MODL Single Speed-2 Speed 35-39" D.O. 220 VDC Motor, 13" Header
GDO-MOD-001L	OP1-0006L	<b>Door Operator</b> , L.H., MODL, Single Speed-2 Speed 40-44" D.O., 220 VDC, 13" Hdr
GDO-MOD-001R	OP1-0006R	<b>Door Operator</b> , R.H., MODL, Single Speed-2 Speed 40-44" D.O., 220 VDC, 13" Hdr
GDO-MODL-KIT	OP1-0089L	<b>MODL Door Operator Kit</b> , ss-2s, with 220 VDC Motor
GDO-VFE2500-001L		<b>Door Operator</b> , L.H., VFE2500-HL, Closed Loop, 42x84, Single Speed
GDO-VFE2500-001R		<b>Door Operator</b> , R.H., VFE2500-HL, Closed Loop, 42x84, Single Speed

## Door Parts and Equipment

GAL

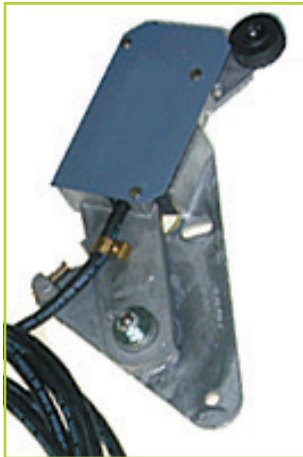

GDO-10



GDO-22



GDO-22A



GDO-10B



GDO-22C



GDO-22D

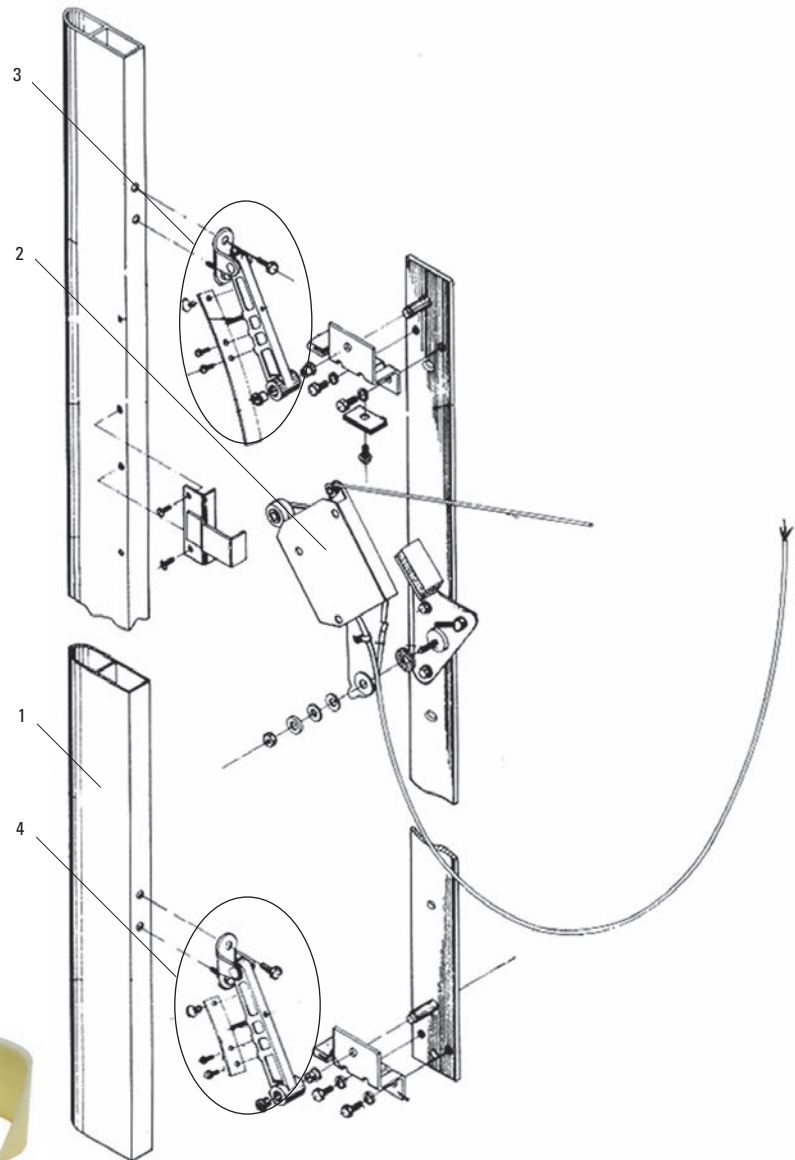

### Type RA Safety Edge Equipment

Item #	S.E.E.S. #	O.E.M. #	Description
1	<b>GSE-1B</b>	SE5-0015N	<b>Nosing</b> , replacement for Safety Edge, Type RA
	<b>GDO-10</b>	SE2-0001R	<b>Switch Assembly, R.H.</b>
2	<b>GDO-10A</b>	SE2-0001L	<b>Switch Assembly, L.H.</b>
	<b>GDO-10B</b>	SE2-0006N, SE-2-9	<b>Micro Switch</b> , sold separately, also included in GDO-10 and GDO-10A
3	<b>GDO-22</b>	SE-5-5, SE5-0018N	<b>Pivot Arm and Leaf Spring</b> , assembly, Upper
4	<b>GDO-22A</b>	SE5-0020N, SE-5-5	<b>Pivot Arm and Leaf Spring</b> , assembly, Lower
	<b>GDO-22C</b>	SE-5-12, HWBS-0003N	<b>Bushing</b> , plastic for pivot arm, 7/16"
	<b>GDO-22D</b>	HWBS-0002N	<b>Bushing</b> , Nyliner 5/8 I.D. TYPE 4 Sleeve Type 4

# Door Parts and Equipment

## Belts

S.E.E.S. #	O.E.M. #	Description
GBLT-1	2440, 4L40, 4L440	<b>Door Operator Belt</b> , 1/2" x 40" V Belt HWBL-0001N



GBLT-1

## Electric Eye Assembly Type "T"

S.E.E.S. #	O.E.M. #	Description
GDO-27B	EE-1-1	<b>Power Pack</b>
GT-4	EE-1-6	<b>Lamp Assembly</b> , 253X lamp, lamp socket with leads
ML-111	SE-7	<b>Lamp</b> , 253X, replacement lamp



GDO-27B



## Hanger Rollers

S.E.E.S. #	O.E.M. #	Description
GDO-2	456DH4, HH1-0025N	<b>Door Hanger Roller Kit</b> , 3-1/4" diameter roller with bushing and hardware kit, aluminum hub with polyurethane tire
GDO-2W-30PK		<b>Wiper</b> , only for GDO-2, Pack of 30 (Oiled)
GDO-2A	HH10-0041N	<b>Door Hanger Roller Assembly</b> , assembly includes; nylon wheel 2-1/4" O.D. x 9/16" shown above, mounting bracket and hardware required to replace "old style" steel roller.
GDO-2AW	DRP9999N	<b>Wiper</b> , replacement wiper for GDO-2A door roller
GDO-2AP		<b>Hanger Roller</b> , 2-1/4" O.D. aluminum hub with polyurethane tire
GDO-2AP-S		<b>Stud</b> , Hex Bolt for GDO-2AP 3/4" Hex, 1/2-20 thread, with Grease Hole
GDO-2B		<b>Door Hanger Roller</b> , 3-1/4" diameter roller, aluminum hub with polyurethane tire. Used in GDO-2
GDO-2C	G401AM	<b>Hanger Roller</b> , 3-1/4" O.D. X .6693" I.D. with axle stud, 7/16-20 thread
GDO-2D		<b>Hanger Roller</b> , 3-1/4" O.D. with 7/16-20 Stud & Hardware
GDO-2N	HH1-0025N	<b>Door Hanger Roller Kit</b> , 3-1/4" Dia. roller with wiper, steel hub with nylon tire
GDO-2N-KIT		<b>Door Hanger Roller Kit</b> , 3-1/4" diameter roller with wiper and hardware kit, steel hub with nylon tire
GDO-2N-SET		<b>Door Hanger Roller Set</b> , 3-1/4" O.D. Nylon with Wiper, Hdw, Bushing
GDO-2S	456DH4	<b>Door Hanger Roller</b> , 3-1/4" diameter roller, steel hub with polyurethane tire
GDO-2SKW-B	HH5-0028N	<b>Roller Kit</b> , 3-1/4" steel roller with Type "C" wiper & hardware
GDO-2SK		<b>Door Roller</b> , 3-1/4" O.D. with hardware, steel version, made of GDO-2S and GDO-2-XHDW-KIT
GDO-2W	HH1-0026N	<b>Wiper</b> , replacement wiper for GDO-2N door roller
GDO-2W-B	HH5-0029N	<b>Wiper</b> , Oiler for Type "C" 3-1/4" hanger roller
GDO-2-INSERT		<b>Reducer Bushing</b> , insert for GDO-2, GDO-2N and GDO-2S
GDO-2-XHDW-KIT		<b>Hardware Kit</b> for hanger roller used in GDO-2 & GDO-2SK



GAL

## Hanger & Track Assemblies

S.E.E.S. #	O.E.M. #	Description
GDO-CDT-001	CDH1-0104N	Hi Cab Kit, 4" Channel - 44-1/2" Long
GDO-CDH-001	CDH4-0110N	Car Hanger Assembly, A-2SCP 32-49 D.O., Ungeared Car, For Hi-Cab
GDO-CDH-001A		Car Hanger Assembly, A-2SCP 32-35 D.O. = 61" Track and Header, Ungeared Car, For Hi-Cab
GDO-CDH-001B		Car Hanger Assembly, A-2SCP 36-38 D.O. = 64" Track and Header, Ungeared Car, For Hi-Cab
GDO-CDH-001C		Car Hanger Assembly, A-2SCP 39-41 D.O. = 67" Track and Header, Ungeared Car, For Hi-Cab
GDO-CDH-001D		Car Hanger Assembly, A-2SCP 42-44 D.O. = 70" Track and Header, Ungeared Car, For Hi-Cab
GDO-CDH-001E		Car Hanger Assembly, A-2SCP 45-47 D.O. = 73" Track and Header, Ungeared Car, For Hi-Cab
GDO-CDH-001F		Car Hanger Assembly, A-2SCP 48-49 D.O. = 76" Track and Header, Ungeared Car, For Hi-Cab
GDO-CDH-001R		Car Hanger Assembly, A-2SCP 48-49 D.O. = 76" Track and Header, Ungeared Car, For Hi-Cab
GDO-CDH-002	CDH29-0010R	Car Hanger Assembly, A-2S 47-48 For CWZ-2 Car Geared
GDO-HDT-001	HH1-0017N	Hanger Track, Hatch Door 40-42 Single Speed 82" Lg with hardware
GDO-HDT-001A	HH19-0026N	Hanger Track, Hatch Door 40-42 Single Speed 82" Lg Zinc Plate
GDO-HDT-002	HH1-0016N	Hanger Track, Hatch Door 37-39 Single Speed 76" Lg with hardware
GDO-HDT-003	HHN-0018N	Hanger Track, Hatch Door 43-45 Single Speed 88" Lg with hardware
GDO-HDT-004	HH1-0015N	Hanger Track, Hatch Door 34-36 Single Speed 70" Lg with hardware
GDO-4	HH19-0007N	Hanger Assembly, Hatch door AW-SS 40"- 42" with top safety retainer
GDO-4A	HH19-0005N	Hanger Assembly with Track, AW-SS 34" D.O. with top safety retainers Yellow Zinc
GDO-4B	HH1-0100N	Hanger Assembly, Hatch Single Speed Type A 34"-36" with Top Ret
GDO-4C	HH1-0101N	Hanger Assembly, Hatch Single Speed Type A 37"-39" with Top Ret
GDO-4D	HH1-0102N	Hanger Assembly, Hatch Single Speed Type A 40"-42" with Top Ret
GDO-4E	HH1-0103N	Hanger Assembly, Hatch Single Speed Type A 43"-45" with Top Ret
GDO-4F	CDH2-0010L	Hanger, A-2SP 47"-48" D.O. Car Geared
GDO-4H	HH2-0165L	Hanger, A-2SP 47"-48" D.O. Ungeared Hatch

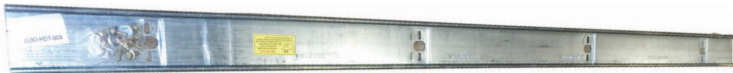

GDO-HDT-003



GDO-4



GDO-4D



GDO-4H



GDO-HDT-001



GDO-4B



GDO-4F



GDO-CDH-001R

## Hanger & Track Assemblies

S.E.E.S. #	O.E.M. #	Description
GDO-4HR	HH2-0165R	Hanger, A-2SP 47"-48" D.O. Ungeared Hatch, Right Hand
GDO-11	HH1-0022R	Door Hanger Assembly, sheave assembly complete R.H. 4-1/8" CL with 3/8-16 Bolts
GDO-11-P		Door Hanger Assembly, Type A, R.H. with poly roller
GDO-11A	HH1-0022L	Door Hanger Assembly, sheave assembly complete L.H. 4-1/8" CL with 3/8-16 Bolts
GDO-11A-P		Door Hanger Assembly, Type A, L.H. with poly roller
GDO-11B	HH3-0034R	Door Hanger Assembly, Sheave assembly complete, R.H. with Top Safety Retainers
GDO-11C	HH3-0034L	Door Hanger Assembly, Sheave assembly complete, L.H. with Top Safety Retainers
GDO-11D		Shim, "C" washer 0.030" TK for door hanger (Bag of 50)
GDO-11E		Kit, Shims & Hardware for GAL door hanger assembly
GDO-11F	HH1-0027N	Shim, 1/32 "A" sheave 3/8" bolts
GDO-11G	HH1-0031N	Shim, 1/8 "A" sheave 3/8" bolts
GDO-11H	HH1-0112N	Retainer, Type "A" Top Safety with hardware
GDO-11J	HH12-0094R	Bumper, Type "OS" CP Assembly Stop, R.H.
GDO-11K	HH12-0094L	Bumper, Type "OS" CP Assembly Stop, L.H.
GDO-11L		Pendant Bolt, for GAL Hanger 3/8-16 x 6" with hardware
GDO-11M		Track Spacer, 1/8" 11 Gauge
GDO-240L	HH2-0206L	Sheave, 4.125 CL 3/8-16 2SP Fast, with Top Safety Retainers
GDO-240R	HH2-0206R	Sheave, 4.125 CL 3/8-16 2SP Fast, with Top Safety Retainers
GDO-241L	HH2-0208L	Sheave, 4.125 CL 3/8-16 2SP Slow, with Top Safety Retainers
GDO-241R	HH2-0208R	Sheave, 4.125 CL 3/8-16 2SP Slow, with Top Safety Retainers



## Closers and Grasshoppers

S.E.E.S. #	O.E.M. #	Description
GDO-60	CL5-0072N	Bracket, assembly, 2/SP Slow Door Closer 3" C.L.
GDO-112L	CL5-0012L	Closer, L.H., 2S 36-40 DO & 2CP 71-82 DO Spring
GDO-113L	CL5-0013L	Closer, L.H., 2S 41-44 DO & 2CP 83-90 DO Spring
GDO-120	CL5-0020N	Closer, Arm SS-CP 36"
GDO-121	CL5-0021N	Closer, Arm SS 42"
GDO-122	CL5-0022N	Closer, Arm 2S-2SCP 42"
GDO-123	CL5-0023N	Closer, Arm SS 48"
GDO-124	CL5-0024N	Closer, Arm 2S-2SCP 48"
GDO-125	CL5-0025N	Closer, Arm SS 52"
GDO-157	CL5-0057N	Closer, Base, Double Spring
GDO-159	CL5-0059N	Closer, Guide, Double Spring
GDO-164	CL5-0064N	Closer, Link Slow door Closer (6 3/4" - 8") Combo (S + A)
GDO-168	CL5-0068N	Closer, Link Slow door Closer (10 3/4"-11 3/4") Combo (S + J)
GDO-201L	CL5-0101L	Closer, LH, 3SP 43 D.O. & 3SCP 87-88 D.O. Spring
GDO-201R	CL5-0101R	Closer, RH, 3SP 45 D.O. & 3SCP 91-92 D.O. Spring
GDO-220	CL5-0259N	Plate, Closer Reinforcement with Studs, 4-20 x1"



GDO-60



GDO-157



GDO-159



GDO-168



GDO-113L



GDO-220



GDO-124

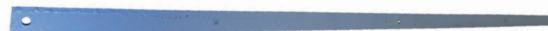

GDO-125



## Door Parts

S.E.E.S. #	O.E.M. #	Description
GDO-25	HH1-0024N	<b>Sheave Eccentric</b> replacement roller, incl. in above assemblies
GDO-25A	HH1-0021N	<b>Cam Kit</b> , Hanger Track Adj Cam, 5/16"-18, lock washer and screw
GDO-86	HH2-0172L	<b>Mechanical Interconnecting Device</b> , set 1-1/2" CL- 3/8" MTG bolts, Left Hand, (shown)
GDO-86B	HH2-0173L	<b>Door Part</b> , Mechanical L.H. A set 1-1/2" CL- 3/8" MTG
GDO-86C	HH2-0177L	<b>Door Part</b> , Mechanical L.H. A set 1-1/2" CL- 1/2" MTG
GDO-87	HH2-0172R	<b>Mechanical Interconnecting Device</b> , set 1-1/2" CL- 3/8" MTG bolts, R.H.
GDO-87B	HH2-0173R	<b>Door Part</b> , Mechanical R.H. A set 1-1/2" CL- 3/8" MTG
GDO-87C	HH2-0177R	<b>Door Part</b> , Mechanical R.H. A set 1-1/2" CL- 1/2" MTG
GDO-88L	CLU16-0016R	<b>Linkage</b> , CWZ-2, Left
GDO-88R	CLU16-0016R	<b>Linkage</b> , CWZ-2, Right
GDO-89	CLU4-0024N	<b>Cable &amp; Cam</b> , Type "C Low & CW Low" Clutch
GDO-89A	CLU4-0023N	<b>Cable &amp; Cam</b> , Type "C & CW" Clutch
GDO-89B	CLU4-0025N	<b>Cable &amp; Cam</b> , Type "C & CW" Clutch
GDO-91L	CLU16-0019L	<b>Cam</b> , C-2/CW-2/CWZ-2 Clutch Cable Locking, L.H.
GDO-91R	CLU16-0019R	<b>Cam</b> , C-2/CW-2/CWZ-2 Clutch Cable Locking, R.H.
MIS-119	INT1H-0034N	<b>MO Key</b> , door key with flapper and collar, slide door
MIS-119-P		<b>Door Key</b> , Flapper with plastic handle and flexible safety shaft
MIS-121A	INT5-0030N	<b>M/N Key</b> , swing door
MIS-124		<b>Spirator</b> , reel closer with cable, for square shaft
MIS-124-ST		<b>Spirator</b> , 6" SmarTork door closer, up to 20% more tension
MIS-124-ST-BK		<b>Bracket</b> , for Smar-Tork door closer
GDO-7	CL6-0003N	<b>Spirator Bracket</b> , 3-1/2" x 2-1/2"
SEES-KCDK-001		<b>SEES Keychain Door Key</b> , "GAL" Flapper Flexible Shaft with Key Ring



GDO-25



GDO-25A



GDO-86



GDO-88R



GDO-7



GDO-89



GDO-89A



MIS-119



MIS-119-P



MIS-124



MIS-124-ST



SEES-KCDK-001



GDO-8A

GDO-8C

## Door Parts and Equipment

### Tension Pulley Assembly

S.E.E.S. #	O.E.M. #	Description
GDO-8A	HH3-0042R,	<b>Tension Pulley Assembly</b> , R.H., (shown)
GDO-8B	HH3-0042L	<b>Tension Pulley Assembly</b> , L.H.
GDO-8C	HWPL-0010N	<b>Idler Pulley</b> , only
GDO-8D	HH3-0032N	<b>Relating Cable</b> , center parting doors, 48" standard or specify required length
GDO-8D-A	CDH2-0078N	<b>Relating cable</b> , for side parting doors 48" L
GDO-8D-C	HH3-0028N	<b>Relating cable assembly</b> , 36", center opening
GDO-8D-E	HH3-0030N	<b>Relating cable</b> , for center parting doors 42" L
GDO-8D-SWG		<b>Swage for Relating Cables</b> , Pack of 5



GDO-8D



GDO-8D-A



GDO-8D-C



GDO-8D-E

## Tension Pulley Assembly

S.E.E.S. #	O.E.M. #	Description
GDO-8E	HH3-0030N	Cable Kit, CYR PT 42" center relating
GDO-8E-A	HH3-0070N	Relating Cable Assy, with GDO-8A, B Pulleys
GDO-8F	CDH2-0079N	Pulley Assembly, 2SP gearing bolt, use for jobs after mid Nov. 1991, roller dia. 2-3/4"
GDO-8D-SPECIAL		Relating Cable Assembly, special size



GDO-8E



GDO-8E-A



GDO-8F

## Pick-Up Assembly MOH Release

S.E.E.S. #	O.E.M. #	Description
GDO-12	INT1H-0022R	Pick-Up Roller Assembly, MOH Horizontal Release, R.H.
GDO-12-IRON-KIT		MOH Release, Cast Iron, R.H. Horizontal with Upper Link, Kit
GDO-12A	INT1H-0022L	Pick-Up Roller Assembly, MOH Horizontal INT-1-9-1 L.H. Release, L.H.
GDO-12A-IRON-KIT		MOH Release, Cast Iron, L.H. Horizontal with Upper Link, Kit
GDO-12-KIT		Pick-Up Roller Assembly Kit, MOH - Release, R.H. Horizontal with rod GDO-14
GDO-12A-KIT		Pick-Up Roller Assembly Kit, MOH Release, L.H. Horizontal with rod GDO-14
GDO-12-IRON		Pick-Up Roller Assembly, MOH Horizontal Release, R.H., Iron Base (heavy duty)
GDO-12A-IRON		Pick-Up Roller Assembly, MOH horizontal Release, L.H., Iron Base (heavy duty)
GDO-12B		Hardware Kit, snap pin with nylon bushing for GDO-12/GDO-12A

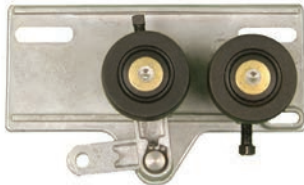

GDO-12

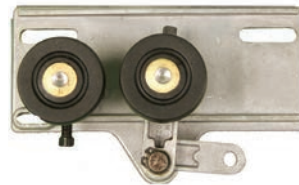

GDO-12A

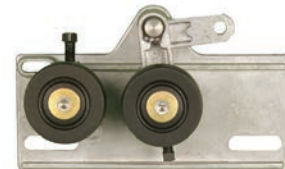

GDO-12-KIT

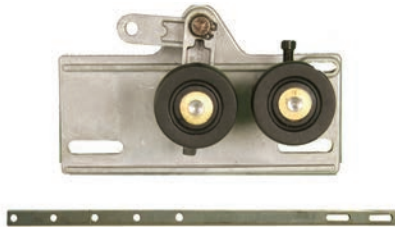

GDO-12A-KIT



GDO-12-IRON



GDO-12A-IRON



GDO-12B

## Door Parts and Equipment

### Pick-Up Assembly MOH & MOM Release

S.E.E.S. #	O.E.M. #	Description
GDO-6	456ES1, INT-1-10, INT1H-0023N	<b>Pick-Up Roller</b> , replacement for roller assemblies. Roller 1-1/2" O.D., 1-5/8" shaft
GDO-6-A	INT-1-10- SHALLOW	<b>Door Pick-up Roller</b> , Shallow Delrin Roller 1-1/2" O.D. x 7/16" TK, with Shaft
GDO-6-S	INT1H-0093N	<b>Roller &amp; Shaft</b> , MO Cut Down 2" OAL
GDO-6-G		<b>Pick-Up Roller</b> , with shaft
GDO-6-P		<b>Pick-Up Roller</b> , 1-1/2" O.D., 1-5/8" shaft, polyurethane
GDO-13	INT1M-0033R	<b>Pick-Up Roller Assembly</b> , MOM Vertical Release, R.H.
GDO-13A	INT1M-0033L	<b>Pick-Up Roller Assembly</b> , MOM Vertical Release, L.H.
GDO-14	INT1H-0026N	<b>Lower Link Assembly</b> , 18-1/2" L
GDO-14A	INT1H-0018N	<b>Upper Link Assembly</b> , 11" L
GDO-14B	HWRV-014N	<b>Retaining Link Pin</b> , for Upper & Lower Interlock Kits
GDO-14C	INT1H-0028N	<b>Lower Link "D"</b> , MO Interlock 26-3/4" Length
GDO-14E	INT1H-0157N	<b>Clamp Set</b> , KMO Emergency Key Flag
GDO-15	INT1H-0016R	<b>MO Keeper Assembly</b> , R.H.
GDO-15A	INT1H-0016L	<b>MO Keeper Assembly</b> , L.H.
GDO-18	INT2H-0015N	<b>MOCP Keeper</b> , Fixed for center parting doors
GDO-19	INT1H-0002R	<b>Interlock Kit</b> , MO Assembly R.H.
GDO-19A	INT1H-0002L	<b>Interlock Kit</b> , MO Assembly L.H.
GDO-19B	INT1H-0031N	<b>Mounting Plate</b> , MO Switch, used on GDO-16
GDO-19C		<b>Hardware kit</b> , for MO interlock assembly
GDO-19D	INT2H-0001N	<b>Interlock Kit</b> , MOCPH A link, C/P 24-39" D.O., includes switch assembly, switch track, mounting plate, horizontal release upper/lower and mounting hardware
GDO-19E	INT1H-0004L	<b>Interlock Kit</b> , MO Assembly L.H. SS45-48 D.O., 2SP 45-52 D.O.
GDO-23		<b>Stationary Cam</b> , Florida flag. Release stationary cam



GDO-6



GDO-13



GDO-13A



GDO-14



GDO-19E



GDO-14B



GDO-15



GDO-18



GDO-23

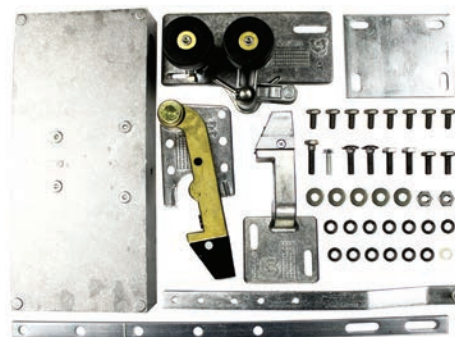

GDO-19D

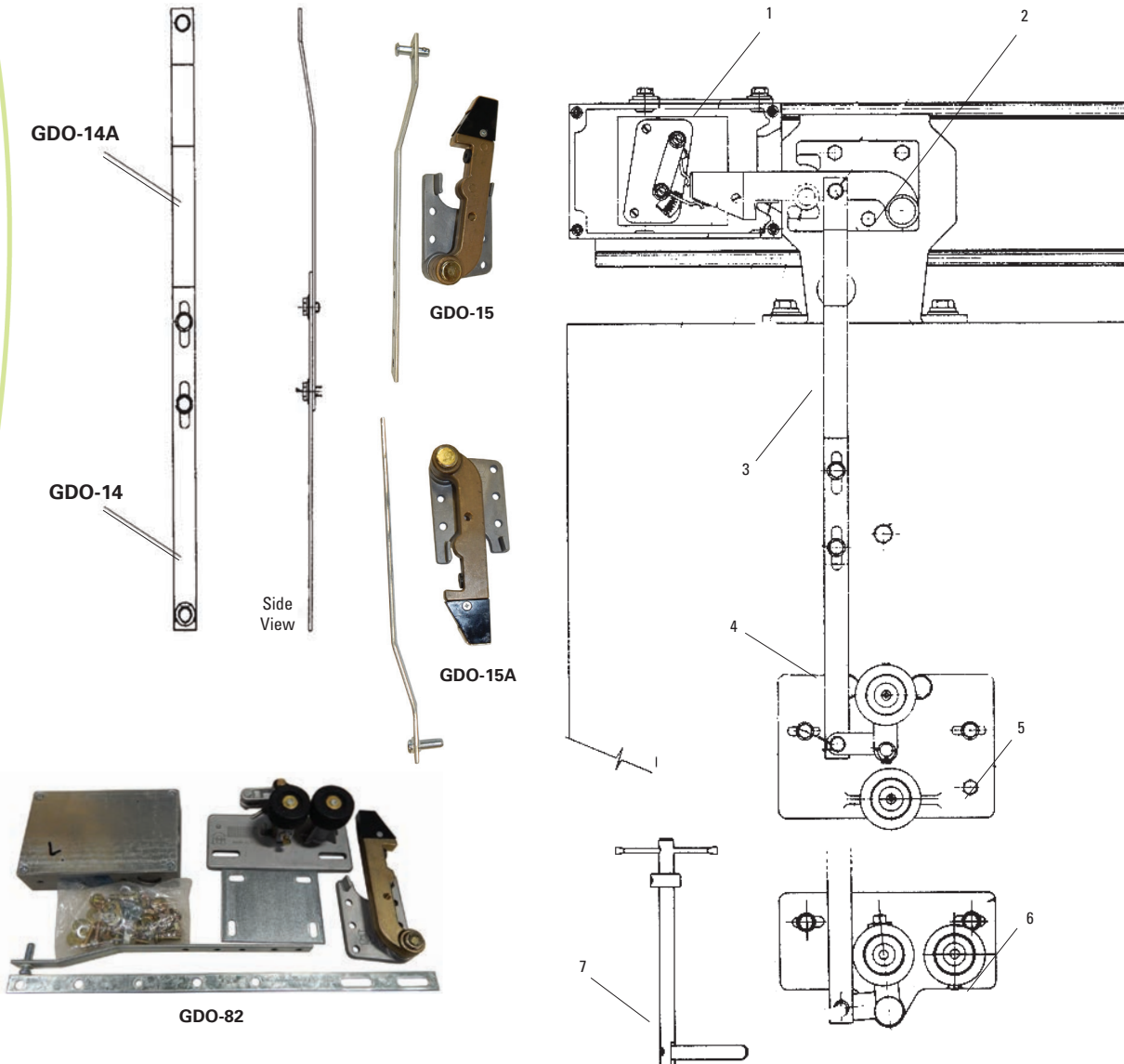

## MOH/MOM Interlock

Item #	S.E.E.S. #	O.E.M. #	Description
1	<b>GDO-17A</b>	INT1H-0013R	<b>MO Interlock Switch, R.H.</b>
	<b>GDO-17B</b>	INT-1-1-LH, INT1H-0013L	<b>MO Interlock Switch, L.H.</b>
	<b>GDO-17C</b>	INT2H-0008N	<b>Cover for Dual Interlock</b>
2	<b>GDO-15</b>	INT1H-0016R	<b>Keeper Assembly, R.H.</b>
	<b>GDO-15A</b>	INT1H-0016L	<b>Keeper Assembly, L.H.</b>
3	<b>GDO-14A</b>	INT1H-0018N	<b>Upper Link Assembly, 11" L</b>
	<b>GDO-14D</b>	INT1H-0027N	<b>Lower Link "C", MO Interlock 22-3/4" Length</b>
4	<b>GDO-14</b>	INT1H-0026N	<b>Lower Link Assembly, 18-1/2" L</b>
5	<b>GDO-13</b>	INT1M-0033R	<b>Vertical Release Assembly, R.H.</b>
	<b>GDO-13A</b>	INT1M-0033L	<b>Vertical Release Assembly, L.H.</b>
6	<b>GDO-12</b>	VP282023, INT-1-9-1-RH	<b>Horizontal Release Assembly, R.H.</b>
	<b>GDO-12A</b>	CTIH-0022L, INT-1-9-1-LH	<b>Horizontal Release Assembly, L.H.</b>
7	<b>MIS-119</b>	INT5-0030N, INT-5-15, INT1-0034N	<b>Flapper Key</b>
	<b>MIS-119-P</b>		<b>Door Key, Flapper with plastic handle and flexible safety shaft</b>
	<b>GDO-82</b>	INT1E-0001L	<b>Interlock Kit, MOH A link BSI-CE S/S 20"-29" 2sp/Cp &amp; Cp 33"-39" D.O., Left Hand</b>
	<b>GDO-82A</b>	INT1E-0001R	<b>Interlock Kit, MOH A Link, R.H. SS (20-29), 2 Sp,Cp 33-39 D.O.</b>

## Door Parts and Equipment

### Gate Switches

S.E.E.S. #	O.E.M. #	Description
<b>GW-3</b>	SW1-0007N	<b>Roller and Bolt</b> , Roller 1.25" O.D. x 1/2" W, Bolt 1.40" L x .43 W, for gate switch
<b>GDO-3</b>	INT2H-0017R, INT1H-0036R, INT-1-15RH(MOKT)	<b>Door Contact Kit</b> , R.H., includes GDO-3C
<b>GDO-3A</b>	INT1H-0036L, INT-1-15LH, INT-1-15LH(MOKT)	<b>Door Contact Kit</b> , L.H., includes GDO-3C
<b>GDO-3C</b>	INT2H-0015N, INT-1-5, INT1H-0017N	<b>Contact</b> , Bridging Block for GDO-3 & 3A
<b>GDO-3D</b>	INT1H-0024L	<b>Contact Base</b> , Left Hand interlock with insulator and hardware
<b>GDO-3E</b>	INT1H-0024R	<b>Contact Base</b> , Right Hand interlock with insulator and hardware
<b>GDO-3E-A</b>	INT2H-0018R	<b>Contact Base</b> , RH MOCP interlock with insulator and hardware
<b>GDO-5</b>	SW1-0003N, SW1-0012N, SWC-1-445, SW-1-15	<b>Gate Contact Kit</b> For GDO-16 Gate Switch
<b>GDO-16</b>	SW-G-1 SW1-0001N	<b>Gate Switch</b> complete, Type G, made of die-cast aluminum, the two studs permit left or right hand use
<b>GDO-16-KIT</b>	SW1-0048N	<b>Switch Assembly</b> , "G" Gate, MODL Kit with Gate Switch Roller
<b>GDO-16B</b>	SW-1-6 SW1-0005N	<b>Arm and Roller Assembly</b> , to make with gate switch
<b>GDO-16G</b>	INT5-0027N	<b>Roller Arm Wheel</b> , roller with bolt
<b>GDO-16K</b>	SW1-0044N	<b>Switch Assembly</b> , "G" Gate including Mounting Bracket & Hardware



GW-3

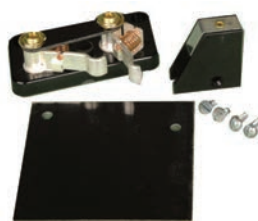

GDO-3A



GDO-3C



GDO-3D



GDO-5



GDO-16



GDO-16B



GDO-16G



GDO-16K

## Door Parts and Equipment

### Gate Switches

S.E.E.S. #	O.E.M. #	Description
GDO-17	INT-2-1, INT2H-0007N	<b>Dual Interlock Switch Assembly</b> , for center parting doors
GDO-17A	INT-1-1-RH, INT1H-0013R	<b>MO Interlock Switch</b> , R.H.
GDO-17B	INT-1-1-LH, INT1H-0013L	<b>MO Interlock Switch</b> , L.H.
GDO-17D	INT1H-0014N	<b>Cover for Interlock MO</b>
GDO-56	SM-INT-6-RH	<b>Door Lock Assembly</b> , Right Hand INT6-0001R
GDO-56A	SM-INT-6-LH	<b>Door Lock Assembly</b> , Left Hand
GDO-56B	INT5-0025N	<b>Arm &amp; Roller</b> , for Door Lock
GDO-56C	INT5-0017N	<b>Contact Base</b> , Lower for M Interlock
GDO-56D	INT5-0016N	<b>Contact Base</b> , Upper for M Interlock
GDO-56E	INT5-0018N	<b>Contact</b> , M/N/NHA Cam bridging
GDO-56F	INT5-0024N	<b>Arm &amp; Roller</b> , for Door Lock 3" CL
GDO-56G	INT5-0026N	<b>Arm &amp; Roller</b> , for Door Lock 7-1/2" CL
GDO-56H	INT5-0014	<b>Contact Kit</b> , Upper for M Interlock
GRP-45	INT5-0015N	<b>Contact Kit</b> , M interlock lower
GDO-56J	INT18-0015N	<b>Contact</b> , WP/WX Interlock Bridging
GDO-56K	INT007-0020N	<b>Interlock</b> , "DM" with 4-1/2" CL Roller Arm
GDO-56M-R	INT22-0007R	<b>Interlock</b> , Kit Slide Type N, R.H.
GDO-56N-R	INT18-0001R	<b>Interlock</b> , Swing Manual Hatch, R.H.
GDO-56N-L	INT18-0001L	<b>Interlock</b> , Swing Manual Hatch, L.H.



GDO-17



GDO-17A

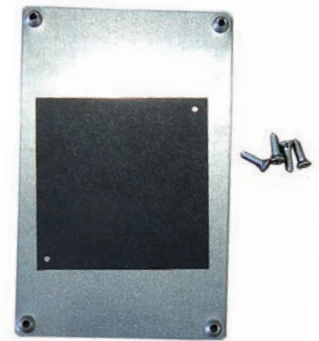

GDO-17D



GDO-56



GDO-56D



GDO-56K



GDO-56G



GDO-56J



GDO-56H

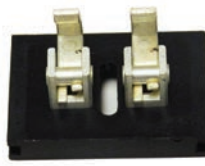

GDO-56N-L

## Door Parts and Equipment

### Door Operator Components

S.E.E.S. #	O.E.M. #	Description
GDO-9	INT1H-0035N, INT-2-24, INT-1-19	<b>MO Jumper</b> (Tomahawk)
GDO-9A	INT5-0029N	<b>Jumper</b> , M/N Interlock
GDO-9B	INT5-0024N	<b>Jumper</b> , M/N/MO Interlock
GDO-16A	OP10-0007N, OP-10-2D	<b>Bridging Cam Assembly</b> (4 pieces; 2 large, 2 small)
GDO-16D	OP-10-0014N, PIN-0045N	<b>Nylon Cam Pin</b> , 1/8" x 5/8" for GDO-16A
GDO-16E	OP-10-0013N, PIN-0044N	<b>Nylon Cam Pin</b> , 5/32" x 5/8" for GDO-16A
GDO-30	OP-10-5RH	<b>Drive Pulley</b> , "MOD", R.H., Operator Drive Pulley and bearing block assembly includes chain and U bolts, nuts and lockwashers, rubber suppressor with rivets, bearing with bearing block, stop roller and bracket, roller and bolt
GDO-30A	OP-10-5LH OP10-0029N	<b>Drive Pulley</b> , "MOD", L.H.
GDO-30B	OP-10-0037N	<b>U-Bolt Kit</b> , 3/8", MOD Drive Chain
GDO-30C	OP10-0036N	<b>Chain Assembly</b> , MOD drive pulley
GDO-30D	RC1-0017N	<b>Clamp Kit</b> , Retiring Cam Pick Up



GDO-9



GDO-9A



GDO-9B

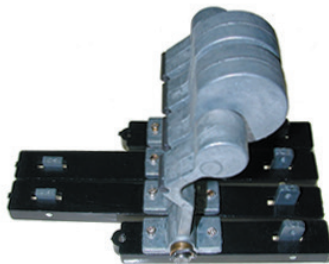

GDO-16A



GDO-30



GDO-30B

## Door Operator Components

S.E.E.S. #	O.E.M. #	Description
<b>GDO-31</b>	OP10-0005R	<b>Contact Base Assembly, R.H.</b> , includes contact base and 3/8" silver contact screw 3/4" long, 12 required
<b>GDO-31A</b>	OP-10-2A, OP10-0005L	<b>Contact Base Assembly, L.H.</b> , includes contact base and 3/8" silver contact screw 3/4" long, 12 required
<b>GDO-32</b>	OP10-0010N, OP-10-2E	<b>Bridging Contact, Upper</b> , with Pin
<b>GDO-32A</b>	OP-100011N	<b>Bridging Contact, Lower</b> , with Pin
<b>GDO-33</b>	OP-10-5C, OP10-0034N	<b>Bearing with Bearing Block</b> , replacement for MOD operator drive pulley. Shaft 5/8" diameter extends 1.5" and 3.250"
<b>GDO-83</b>	OP10-0004R	<b>Switch assembly, MOD limit, R.H.</b>
<b>GDO-90</b>	OP10-0004L	<b>Switch assembly, MOD limit, L.H.</b>
<b>GRP-3</b>	CONT-0003N, OP10-006N	<b>Contact</b> , silver contact screws 3/8" diameter x 3/4" long for contact base
<b>GDO-35</b>	OP-10-5D1, OP10-0040N, LC-0058N	<b>Roller and Bolt</b>
<b>GDO-35A</b>	OP10-0032N, OP-10-0032N	<b>Stop</b> , operator pulley aluminum block
<b>GDO-35B</b>	OP10-0072N	<b>Stop Assembly</b> , for Operator Pulley Jobs after April 30, 2006
<b>GDO-35C</b>	OP21-0018N	<b>Stop Assembly</b> , for Operator Pulley MOVFR before 5-1-06
<b>GDO-35D</b>	OP21-0025N	<b>Stop Assembly</b> , for Operator Pulley Jobs After 4-30-06
<b>GDO-35E</b>	OP11-0015N	<b>Roller Assembly</b> , Oper Retiring, Cam-Pickup before 5-1-2006
<b>GDO-35F</b>	OP11-0031N	<b>Roller Assembly</b> , Oper Retiring, Cam-Pickup After 4-30-2006
<b>GDO-35G</b>	OP26-0003N	<b>Stop Roller</b> , Old Style Power Failure Emergency Unlocking Device PFU-1/2
<b>GDO-35H</b>	OP21-0014N	<b>Roller Plate Assembly</b> , Oper Retir Cam Pick Up for CT Panel Operator
<b>GDO-35J</b>	OP21-0015N	<b>Roller Plate Assembly</b> , Oper Retir Cam Pick Up for MOM/MOH Operator
<b>GDO-35K</b>	OP21-0016N	<b>Roller</b> , Bolt, Retiring Cam Pick Up Roller for All Operator



GDO-31A



GDO-32



GDO-32A



GRP-3

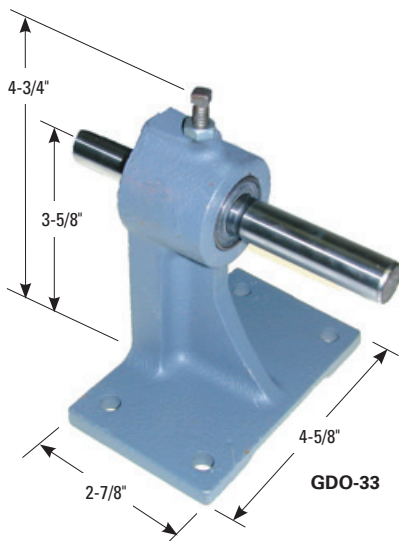

GDO-33



GDO-83



GDO-90



GDO-35

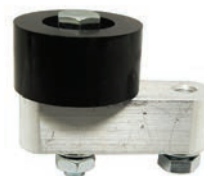

GDO-35A



GDO-35B



## Door Operator Components

S.E.E.S. #	O.E.M. #	Description
GDO-34	OP-10-3, OP10-0015L, LC-0057N	<b>Cams</b> , set of activating cams, six pieces, MOD Limit Control
GDO-34A	OP-10-0015N	<b>Cam</b> , set of activating cams, R.H., set 6 pieces
GDO-36	OP10-0009N,OP-12-2D-1	<b>Bridging Cam</b> , Large
GDO-37	OP10-0008N,OP-12-2D-2	<b>Bridging Cam</b> , Small
GDO-39	OP-12-2F	<b>Spring</b> for Bridging Contact, positioned between cam and bridging contact
GDO-40	OP-12-3, OP-12-0006R	<b>Activating Cam set</b> , assembly includes eight cams for MOM and MOH Operator Limit Control to control opening and closing cycles
GDO-56F	INT5-0024N	<b>Arm &amp; Roller</b> for Door Lock 3" CL
GDO-56G	INT5-0026N	<b>Arm &amp; Roller</b> for Door Lock 7-1/2" CL
GDO-57	CL5-5A, CL5-0051N, SPG-0046N	<b>Spring Closer</b> , 18-1/2" L
GDO-57A	CL-5-5, CL5-0051N	<b>Door Closer Assembly</b> , spring, rod and yoke
GDO-57B		<b>Nylon Sleeve</b> , for GDO-57A
GDO-58	INT5-0019N	<b>Contact Block</b> , for GDO-51, 52, 53, 54 keeper assemblies
GDO-16A	OP10-0007N, OP-10-2D	<b>Bridging Cam Assembly</b> (4 pieces; 2 large, 2 small)



## Door Parts and Equipment

### Door Operator Components

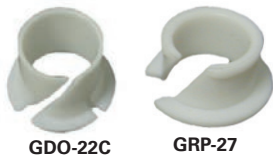

GDO-22C

GRP-27



GRP-32

GDO-41



GDO-42



GDO-43



GDO-44H



GDO-59Q



GDO-45



GDO-44B

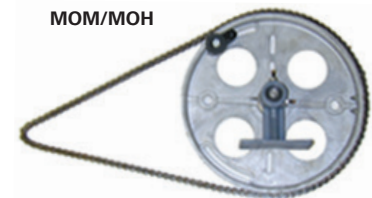

GDO-44

S.E.E.S. #	O.E.M. #	Description
<b>GDO-22C</b>	SE-5-12, HWBS-0003N	<b>Bushing</b> , plastic, for pivot arm
<b>GRP-27</b>	LC-8.1-70, HWBS-0001N	<b>Nylon Bushing</b>
<b>GRP-32</b>	LC-23.1-60, HWBS-0006N	<b>Nylon Bushing</b>
<b>GDO-41</b>	OP-12-4F, HWBS-0004N	<b>Nylon Bushing</b> , 5/8"
<b>GDO-42</b>	OP20-0002N, OP-20-0002N	<b>Intermediate Pulley</b> and bearing block assembly for 1/2" chain, MOML, 1/2" 12 tooth
<b>GDO-42A</b>	PL-0001N, OP20-0001N	<b>Intermediate Pulley</b> and bearing block assembly for 3/8" chain, MOD, 3/8" 15 tooth
<b>GDO-43</b>	OP-20-2, OP-20-0005N	<b>Bearing Block</b> , block only, replacement for above assemblies
<b>GDO-44</b>	OP-21-1RH, LH, OP-21-0001N	<b>Drive Pulley and bearing block</b> , R.H. or L.H.
<b>GDO-44C</b>	OP21-0005N	<b>Chain Assembly</b> , MOM drive pulley
<b>GDO-44B</b>	OP21-0006N, OP10-0037N	<b>U-Bolt Kit</b> , 1/2", MOM Drive Chain
<b>GDO-44E</b>	OP21-0017N	<b>Pully Assembly</b> , MOVFR/MOVR II Operator Drive, MOCT (Old)
<b>GDO-44FL</b>	OP21-0009L	<b>Drive Pulley Assembly</b> , MOML/MOHL "L" Type Panel Operator, L.H.
<b>GDO-44FR</b>	OP21-0009R	<b>U-Bolt Kit</b> , MOML/MOHL "L" Type Panel Operator, RH
<b>GDO-44G</b>	OP71-0022N	<b>Pully Assembly</b> , MOX with Sprocket Drive
<b>GDO-44H</b>		<b>Chain</b> , "MOVFRW"/"MOW", #40 Drive Pully, 60" Long with Clamps, Nickel Plated
<b>GDO-44J</b>	OP-21-0026N	<b>Drive Pully</b> , Block, Bearing
<b>GDO-45</b>	OP-21-1C, OP21-0003N	<b>Bearing Block</b> , block only, replacement
<b>GDO-59Q</b>	PMDG-0144N	<b>Link</b> , Type "LWZ-1" Retracting
<b>GDO-59R</b>	CLU9-0005L	<b>Door Clutch Kit</b> , LWZ-2 with 5-1/4" Link, L.H. with hardware
<b>GDO-59T</b>	CLU9-0008L	<b>Door Clutch Kit</b> , LWZ-2 with 16" Link, L.H. with hardware
<b>GDO-59U</b>	CLU9-0008R	<b>Door Clutch Kit</b> , LWZ-2 with 16" Link, R.H. with hardware
<b>GDO-84</b>	OP10-0001R	<b>Limit control</b> , 230V MOD with #35 chain, use for jobs before 5-1-2006
<b>GDO-85</b>	OP10-0001L	<b>Limit control</b> , 230V MOD with #35 chain, use for jobs before 5-1-2006

# Door Parts and Equipment

## Door Operator Components

S.E.E.S. #	O.E.M. #	Description
GDO-100	OP24-0033N	<b>Support Arm</b> , "HA" Drive Arm with 12" LG Plate
GDO-200	OP12-0001L	<b>Limit Control</b> , 230V MOM/MOH with #35 chain
GDO-202	OP22-0009N	<b>Drive Arm Assembly</b> , CP 40"-49" Door Opening
GDO-202A	OP22-0006L	<b>Drive Arm Assembly</b> , SS-2S 45" - 48" D.O.
GDO-202B	OP22-0005L	<b>Drive Arm Assembly</b> , SS-2S 40" - 44" D.O.
GDO-202C	OP22-0004L	<b>Drive Arm Assembly</b> , SS-2S 35" - 39" D.O.
GDO-204	OP34-0079N	<b>Plate Assembly</b> , CP-2SCP 5" CL Arm Support
GDO-204A	OP22-0178N	<b>Link</b> , for Operator 17-1/4" Long Connecting
GDO-205	CLU3-0335N	<b>Locking Bar</b> , for LWZ-1 Clutch
GDO-210	OP22-0127R	<b>Arm Assembly</b> , SS-2S 45"- 48" D.O.
GDO-230	OP22-0742N	<b>Crank Arm Assembly</b> , CP-2SCP OP Splt C/P 30" - 49" D.O. & 2S/CP 32-49 D.O.
GDO-230A	OP22-0740N	<b>Crank Arm Assembly</b> , S/S, 2/SP, 3SP 13-7/16" Lg
GDO-231	CHD1-0146N	<b>Channel</b> , Type Unistrut Adaptor with Hardware
GDO-232	INT1H-0043N	<b>Plate</b> , Unistrut
GDO-233	INT1H-0197N	<b>Idler Pulley</b> , only
GDO-234	INT1H-0042N	<b>Relating Cable</b> , center parting doors, 48"
GDO-235	OP22-0069N	<b>Bracket</b> , 14" CL Drive Arm Door Link
GDO-236	OP22-0067N	<b>Bracket</b> and 10" CL Drive Arm Door Link
GDO-303R	INT22-0003R	<b>Interlock</b> , for "N" Swing 4-1/2 Flush Mounted Lock (Kalamein Doors)
GDO-303L	INT22-0003L	<b>Interlock</b> , for "N" Swing 4-1/2 Flush Mounted Lock (Kalamein Doors)

\*Also see page 618 for more GAL door closers.



GDO-200



GDO-202



GDO-202A



GDO-204



GDO-205



GDO-204A



GDO-303R



GDO-230



GDO-230A



GDO-235

GAL

## Door Parts and Equipment

### Clutch Links

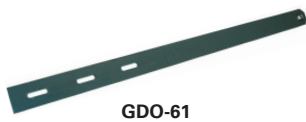

GDO-61



GDO-61A



GDO-61B



GDO-61C



GDO-61G



GDO-61M



GDO-65



GDO-65A



GDO-65B



GDR-115



GDO-26



GDO-26A

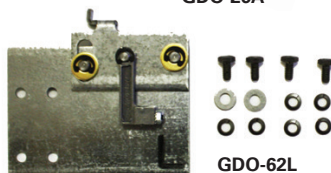

GDO-62L

S.E.E.S. #	O.E.M. #	Description
GDO-59Q	PMDG-0144N	Link, LWZ-1 Retracting
GDO-61	OP22-0179N	Link, Type I, 16-1/2" L Slotted link with bearing
GDO-61A	OP22-0180N	Link, Type II, 24-3/4" L Slotted link with bearing
GDO-61B	OP22-0181N	Link, Type III, 31" L Slotted link with bearing
GDO-61C	CLU9-0090N	Link, Clutch, 12" L for LWZ-2 Clutch
GDO-61D	CLU9-0088N	Link, Clutch, 10" L for LWZ-2 Clutch
GDO-61E	CLU9-0086N	Link, Clutch 8" L for LWZ-2 Clutch
GDO-61F	CLU9-0084N	Link, Clutch 6" L for LWZ-2 Clutch
GDO-61G	CLU9-0085N	Link, Clutch 7" L for LWZ-2 Clutch
GDO-61H	CLU9-0087N	Link, Clutch 9" L for LWZ-2 Clutch
GDO-61J	CLU9-0089N	Link, Clutch 11" L for LWZ-2 Clutch
GDO-61K	CLU9-0091N	Link, Clutch 14" L for LWZ-2 Clutch
GDO-61L	CLU9-0092N	Link, Clutch 16" L for LWZ-2 Clutch
GDO-61M	CLU9-0064N	Link, Clutch 6" with Offset CL LWZ-2-LOW/LWZ-2-RC, LW2-LOW
GDO-61N	CLU9-0065N	Link, Clutch 7" with Offset CL LWZ-2-LOW/LWZ-2-RC, LW2-LOW
GDO-61P	CLU9-0066N	Link, Clutch 8" with Offset CL LWZ-2-LOW/LWZ-2-RC, LW2-LOW
GDO-61Q	CLU9-0067N	Link, Clutch 9" with Offset CL LWZ-2-LOW/LWZ-2-RC, LW2-LOW
GDO-61R	CLU9-0068N	Link, Clutch 10" with Offset CL LWZ-2-LOW/LWZ-2-RC, LW2-LOW
GDO-61S	CLU9-0069N	Link, Clutch 11" with Offset CL LWZ-2-LOW/LWZ-2-RC, LW2-LOW
GDO-61T	CLU9-0070N	Link, Clutch 12" with Offset CL LWZ-2-LOW/LWZ-2-RC, LW2-LOW
GDO-61U	CLU9-0071N	Link, Clutch 14" with Offset CL LWZ-2-LOW/LWZ-2-RC, LW2-LOW
GDO-61V	CLU9-0072N	Link, Clutch 16" with Offset CL LWZ-2-LOW/LWZ-2-RC, LW2-LOW
GDO-65	CLU9-0063N	Link, Clutch 5-1/4" For CL LWZ-2-LOW/LWZ-2-RC, LW2-LOW
GDO-65A	CLU9-0083N	Link, Clutch 5-1/4" L for LWZ-2 Clutch
GDO-65B	CLU9-0259N	Link, Clutch 18" CL LWZ2-LOW/LWZ-2-LRC
GDR-115	CLU3-0336N	Link, LWZ-1 3 15/16" Connecting 2 1/2" x 1/4" Rod
GDR-116	CLU3-0337N	Link, LWZ-1 7 15/16" Connecting 2 1/2" x 1/4" Rod
GDR-117	CLU3-0338N	Link, LWZ-1 11 15/16" Connecting 2 1/2" x 1/4" Rod
GDR-118	CLU3-0339N	Link, LWZ-1 15 15/16" Connecting 2 1/2" x 1/4" Rod
GDR-119	CLU3-0340N	Link, LWZ-1 19 15/16" Connecting 2 1/2" x 1/4" Rod
GDR-120	CLU3-0341N	Link, LWZ-1 23 15/16" Connecting 2 1/2" x 1/4" Rod
GDR-121	CLU3-0342N	Link, LWZ-1 27 15/16" Connecting 2 1/2" x 1/4" Rod
GDR-122	CLU3-0343N	Link, LWZ-1 7 15/16" Connecting 5 1/2" x 1/4" Rod
GDR-123	CLU3-0344N	Link, LWZ-1 15 15/16" Connecting 2 1/2" x 1/4" Rod
GDR-124	CLU3-0345N	Link, LWZ-1 19 15/16" Connecting 2 1/2" x 1/4" Rod
GDR-125	CLU3-0346N	Link, LWZ-1 23 15/16" Connecting 5 1/2" x 1/4" Rod

### Locking Assemblies

S.E.E.S. #	O.E.M. #	Description
GDO-26	BR-0009N, OP-22-12, HWBR-0009N	Bearing Kit for Operator Crank Arm
GDO-26A	HWBR-0008N	Bearing Kit, 7/8" Shoulder for clutch and door links
GDO-62L	CLU9-0115L	Locking Assembly, L.H. For LWZ-2 with 36" Rod and standard cam
GDO-62R	CLU9-0115R	Locking Assembly, R.H. For LWZ-2 with 36" Rod and standard cam



# Door Parts and Equipment

## Locking Assemblies

S.E.E.S. #	O.E.M. #	Description
GDR-001	CLU3-0254L	Locking Assembly, LWZ-1 SS 22-29 D.O. CP 30-39 D.O.
GDR-002	CLU3-0254R	Locking Assembly, LWZ-1 SS 22-29 D.O. CP 30-39 D.O.
GDR-003	CLU3-0255L	Locking Assembly, LWZ-1 CP 24-29 D.O. & 2SCP 32-39 D.O.
GDR-004	CLU3-0255R	Locking Assembly, LWZ-1 CP 24-29 D.O. & 2SCP 32-39 D.O.
GDR-005	CLU3-0256L	Locking Assembly, LWZ-1 2SCP 40-49 D.O.
GDR-006	CLU3-0256R	Locking Assembly, LWZ-1 2SCP 40-49 D.O.
GDR-007	CLU3-0257L	Locking Assembly, LWZ-1 SS-2SP 30-3 D.O., CP 40-49 D.O., Left Hand
GDR-008	CLU3-0257R	Locking Assembly, LWZ-1 SS-2SP 30-3 D.O., CP 40-49 D.O., Right Hand
GDR-009	CLU3-0258L	Locking Assembly, LWZ-1 2SCP 50-59 D.O.
GDR-010	CLU3-0258R	Locking Assembly, LWZ-1 2SCP 50-59 D.O.
GDR-011	CLU3-0259L	Locking Assembly, LWZ-1 SS 40-44 D.O. 2SP 24-29 D.O. 40-44 D.O. CP 50-59
GDR-012	CLU3-0259R	Locking Assembly, LWZ-1 SS 40-44 D.O. 2SP 24-29 D.O. 40-44 D.O. CP 50-59
GDR-013	CLU3-0260L	Locking Assembly, LWZ-1 SS 45-48 D.O. 2SP 45-52 D.O. CP 60-83 D.O. 2SCP 60
GDR-014	CLU3-0260R	Locking Assembly, LWZ-1 SS 45-48 D.O. 2SP 45-52 D.O. CP 60-83 D.O. 2SCP 60
GDR-015	CLU3-0261L	Locking Assembly, LWZ-1 2SP 53-60 D 2SCP 80-83 D.O.
GDR-016	CLU3-0261R	Locking Assembly, LWZ-1 2SP 53-60 D 2SCP 80-83 D.O.
GDR-017	CLU3-0262L	Locking Assembly, LWZ-1 2SP 61-68 D
GDR-018	CLU3-0262R	Locking Assembly, LWZ-1 2SP 61-68 D
GDR-019	CLU3-0263L	Locking Assembly, LWZ-1 2SP 69-72 D
GDR-020	CLU3-0263R	Locking Assembly, LWZ-1 2SP 69-72 D
GDR-021	CLU3-0271L	Locking Assembly, LWZ-1 "C" Hngr SS 22-29 D.O. CP 30-39 D.O. 2SCP 32-39 D
GDR-022	CLU3-0271R	Locking Assembly, LWZ-1 "C" Hngr SS 22-29 D.O.
GDR-023	CLU3-0272L	Locking Assembly, LWZ-1 "C" Hngr SS 2SP 30-39 D.O. CP & 2SCP 40-49 D.O.
GDR-024	CLU3-0272R	Locking Assembly, LWZ-1 "C" Hngr SS 2SP 30-39 D.O.
GDR-025	CLU3-0273L	Locking Assembly, LWZ-1 "C" Hngr SS 2SP 40-44 D.O. CP & 2SCP 50-59 D.O.
GDR-026	CLU3-0273R	Locking Assembly, LWZ-1 "C" Hngr SS 2SP 40-44 D.O.
GDR-027	CLU3-0274L	Locking Assembly, LWZ-1 "C" Hngr SS 45-48 D.O. 2SP 45-52 D.O. 3SP 30-5
GDR-028	CLU3-0274R	Locking Assembly, LWZ-1 "C" Hngr SS 45-48 D.O. 2SP 45-52 D.O. 3SP 30-54 D
GDR-029	CLU3-0275L	Locking Assembly, LWZ-1 "C" Hngr 2S 53-60 D.O. 3SP 53-64 D.O.
GDR-030	CLU3-0275R	Locking Assembly, LWZ-1 "C" Hngr 2S 53-60 D.O. 3SP 53-64 D.O.
GDR-031	CLU3-0276L	Locking Assembly, LWZ-1 "C" Hngr 2S 61-68 D.O. 3SP 65-69 D.O.
GDR-032	CLU3-0276R	Locking Assembly, LWZ-1 "C" Hngr 2S 61-68 D.O. 3SP 65-69 D.O.
GDR-033	CLU3-0277L	Locking Assembly, LWZ-1 "C" Hngr 2S 69-72 D.O.
GDR-034	CLU3-0277R	Locking Assembly, LWZ-1 "C" Hngr 2S 69-72 D.O.
GDR-035	CLU3-0285L	Locking Assembly, LWZ-1 SS 22-29 D.O.
GDR-036	CLU3-0285R	Locking Assembly, LWZ-1 SS 22-29 D.O.
GDR-037	CLU3-0286L	Locking Assembly, LWZ-1 SS-2SP 30-39 D.O.
GDR-038	CLU3-0286R	Locking Assembly, LWZ-1 SS-2SP 30-39 D.O.
GDR-039	CLU3-0287L	Locking Assembly, LWZ-1 SS-2SP 40-44 D.O.
GDR-040	CLU3-0287R	Locking Assembly, LWZ-1 SS-2SP 40-44 D.O.
GDR-041	CLU3-0288L	Locking Assembly, LWZ-1 3SP 30-54 D
GDR-042	CLU3-0288R	Locking Assembly, LWZ-1 3SP 30-54 D
GDR-043	CLU3-0289L	Locking Assembly, LWZ-1 SS-2SP 45-48 D.O.
GDR-044	CLU3-0289R	Locking Assembly, LWZ-1 SS-2SP 45-48 D.O.



GAL

## Door Parts and Equipment

### Locking Assemblies

S.E.E.S. #	O.E.M. #	Description
GDR-045	CLU3-0290L	Locking Assembly, LWZ-1 3SP 55-64 D
GDR-046	CLU3-0290R	Locking Assembly, LWZ-1 3SP 55-64 D
GDR-047	CLU3-0291L	Locking Assembly, LWZ-1 2SP 53-60 D
GDR-048	CLU3-0291R	Locking Assembly, LWZ-1 2SP 53-60 D
GDR-049	CLU3-0292L	Locking Assembly, LWZ-1 3SP 65-69 D
GDR-050	CLU3-0292R	Locking Assembly, LWZ-1 3SP 65-69 D
GDR-051	CLU3-0293L	Locking Assembly, LWZ-1 2SP 61-68 D
GDR-052	CLU3-0293R	Locking Assembly, LWZ-1 2SP 61-68 D
GDR-053	CLU3-0294L	Locking Assembly, LWZ-1 2SP 69-72 D
GDR-054	CLU3-0294R	Locking Assembly, LWZ-1 2SP 69-72 D
GDR-055	CLU3-0295L	Locking Assembly, LWZ-1 CP 24-29 D.O. 2SCP 32-39 D.O.
GDR-056	CLU3-0296L	Locking Assembly, LWZ-1 CP 30-39 D.O.
GDR-057	CLU3-0297L	Locking Assembly, LWZ-1 CP 40-49 D.O.
GDR-058	CLU3-0298L	Locking Assembly, LWZ-1 2SCP 40-49
GDR-059	CLU3-0299L	Locking Assembly, LWZ-1 2SCP 50-59
GDR-060	CLU3-0300L	Locking Assembly, LWZ-1 CP 50-59 D.O.
GDR-061	CLU3-0301L	Locking Assembly, LWZ-1 CP 60-83 D.O. 2SCP 60-79 D.O.
GDR-062	CLU3-0302L	Locking Assembly, LWZ-1 2SCP 80-83
GDR-063	CLU3-0303L	Locking Assembly, LWZ-1 "C" Hngr SS 22-29 D.O.
GDR-064	CLU3-0303R	Locking Assembly, LWZ-1 "C" Hngr SS 22-29 D.O.
GDR-065	CLU3-0304L	Locking Assembly, LWZ-1 "C" Hngr SS 2SP 30-39 D.O.
GDR-066	CLU3-0304R	Locking Assembly, LWZ-1 "C" Hngr SS 2SP 30-39 D.O.
GDR-067	CLU3-0305L	Locking Assembly, LWZ-1 "C" Hngr SS 2SP 40-44 D.O.
GDR-068	CLU3-0305R	Locking Assembly, LWZ-1 "C" Hngr SS 2SP 40-44 D.O.
GDR-069	CLU3-0306L	Locking Assembly, LWZ-1 "C" Hngr SS 45-48 D.O. 2SP-3SP 45-52 D.O.
GDR-070	CLU3-0306R	Locking Assembly, LWZ-1 "C" Hngr SS 45-48 D.O. 2SP-3SP 45-52 D.O.
GDR-071	CLU3-0307L	Locking Assembly, LWZ-1 "C" Hngr 2S 3SP 53-60 D.O.
GDR-072	CLU3-0307R	Locking Assembly, LWZ-1 "C" Hngr 2S 3SP 53-60 D.O.
GDR-073	CLU3-0308L	Locking Assembly, LWZ-1 "C" Hngr 2S 3SP 61-68 D.O.
GDR-074	CLU3-0308R	Locking Assembly, LWZ-1 "C" Hngr 2S 3SP 61-68 D.O.
GDR-075	CLU3-0309L	Locking Assembly, LWZ-1 "C" Hngr 3S 69-72 D.O.
GDR-076	CLU3-0309R	Locking Assembly, LWZ-1 "C" Hngr 3S 69-72 D.O.
GDR-077	CLU3-0310L	Locking Assembly, LWZ-1 "C" Hngr CP 30-39 D.O. 2SCP 32-39 D.O.
GDR-078	CLU3-0311L	Locking Assembly, LWZ-1 "C" Hngr CP 2SCP 40-49 D.O.
GDR-080	CLU3-0313L	Locking Assembly, LWZ-1 "C" Hngr CP 2SCP 60-83 D.O.
GDR-081	CLU3-0314L	Locking Assembly, LWZ-1 3SP 30-54 D
GDR-082	CLU3-0314R	Locking Assembly, LWZ-1 3SP 30-54 D
GDR-083	CLU3-0315L	Locking Assembly, LWZ-1 3SP 55-64 D
GDR-084	CLU3-03153	Locking Assembly, LWZ-1 3SP 55-64 D
GDR-085	CLU3-0316L	Locking Assembly, LWZ-1 3SP 65-69 D
GDR-086	CLU3-0316R	Locking Assembly, LWZ-1 3SP 65-69 D
GDR-087	CLU3-0320L	Locking Assembly, LWZ-1 SS(HA) 24-29 D.O.
GDR-088	CLU3-0320R	Locking Assembly, LWZ-1 SS(HA) 24-29 D.O.
GDR-089	CLU3-0321L	Locking Assembly, LWZ-1 SS(HA) 30-39 D.O.
GDR-090	CLU3-0321R	Locking Assembly, LWZ-1 SS(HA) 30-39 D.O.
GDR-091	CLU3-0322L	Locking Assembly, LWZ-1 2SP(HA) 30-32 D.O.
GDR-092	CLU3-0322R	Locking Assembly, LWZ-1 2SP(HA) 30-32 D.O.
GDR-093	CLU3-0323L	Locking Assembly, LWZ-1 2SP(HA) 33-39 D.O.
GDR-094	CLU3-0323R	Locking Assembly, LWZ-1 2SP(HA) 33-39 D.O.
GDR-095	CLU3-0324L	Locking Assembly, LWZ-1 2S(HA) 40-44 D.O.
GDR-096	CLU3-0324R	Locking Assembly, LWZ-1 2S(HA) 40-44 D.O.
GDR-097	CLU3-0325L	Locking Assembly, LWZ-1 2SP(HA) 45-48 D.O.
GDR-098	CLU3-0325R	Locking Assembly, LWZ-1 2SP(HA) 45-48 D.O.

## Door Parts and Equipment

### Locking Bar Guides

S.E.E.S. #	O.E.M. #	Description
GDR-099	CLU3-0326L	Guide, LWZ-1 Locking Bar SS 22-48 D.O. 2SP 24-72 D.O. 3SP 30-69 D.O. C
GDR-100	CLU3-0326R	Guide, LWZ-1 Locking Bar SS 22-48 D.O. 2SP 24-72 D.O. 3SP 30-69 D.O. C
GDR-101	CLU3-0327L	Guide, LWZ-1 Locking Bar CP 24-29 D.O. 2SCP 32-59 D.O.
GDR-102	CLU3-0327R	Guide, LWZ-1 Locking Bar CP 24-29 D.O. 2SCP 32-59 D.O.
GDR-103	CLU3-0328L	Guide, LWZ-1 "C" Hngr Locking Bar 22-48 D.O. 2SP 30-72 D.O. 3SP 30-6
GDR-104	CLU3-0328R	Guide, LWZ-1 "C" Hngr Locking Bar 22-48 D.O. 2SP 30-72 D.O. 3SP 30-6
GDR-105	CLU3-0329L	Guide, LWZ-1 Locking Bar SS 24-42 D.O.
GDR-106	CLU3-0329R	Guide, LWZ-1 Locking Bar SS 24-42 D.O.
GDR-107	CLU3-0330L	Guide, LWZ-1 Locking Bar 2SP 33-4 D.O.
GDR-108	CLU3-0330R	Guide, LWZ-1 Locking Bar 2SP 33-4 D.O.



GDO-46E

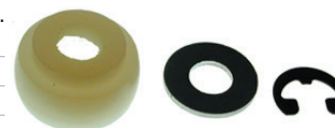

GDO-46C-A

### Door Clutch Kits

S.E.E.S. #	O.E.M. #	Description
GDO-46	OP-30, CLU11-0004N	Car Door Clutch, Type LWZ-2, 8" Arm
GDO-46A	OP-30, CLU11-0006N	Car Door Clutch, Type LWZ-2, 10" Arm
GDO-46B	OP-30-2, CLU1-0033N	Door Open Vane, 24-5/8" for Type L
GDO-46C-A	CLU1-0037N	Roller, 15/16" for GDO-46C
GDO-46C-B	CLU1-0036N	Roller, 13/16" for LW Clutch
GDO-46E	SPG-0019N	Spring, Clutch Vane Return LW & LWZ 4 Per Clutch Assembly
GDO-46F	CLU11-0001N	Clutch LW-2 5-1/4" Link, 2SP 24-26 D.O., 3SP 30-34 CP 23-33
GDO-51	M-14-2, INT4-0001N	Swing Door Keeper
GDO-52	M-14-20, INT4-0002N	Concealed Mounted Keeper
GDO-53	M-14-K, INT4-0003N	Kalomin Keeper
GDO-54	M-14-5, M-14-21-2, INT4-0004N	Slide Door Keeper for swing door
GDR-109	CLU3-0331L	Cam, LWZ-1 Standard Locking assembly
GDR-110	CLU3-0331R	Cam, LWZ-1 Standard Locking assembly
GDR-110A		Cam, LWZ-1 Locking assembly RH Modified
GDR-111	CLU3-0333L	Cam, LWZ-1 Replacement Locking For S/S & 2/SP Jobs Prior June 9
GDR-112	CLU3-0333R	Cam, LWZ-1 Replacement Locking For S/S & 2/SP Jobs Prior June 9
GDR-113	CLU3-0334L	Cam, LWZ-1 Replacement Locking For C/P, 2SP/CP Jobs Prior June 9

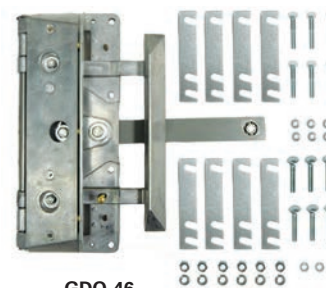

GDO-46

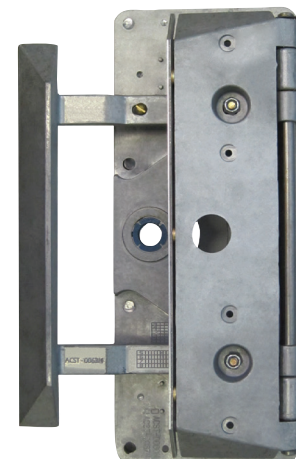

GDO-46A



GDO-46B

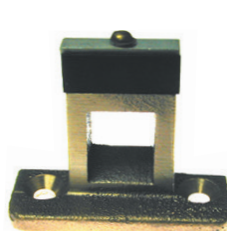

GDO-51

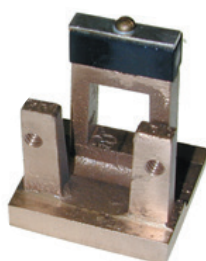

GDO-52



GDO-53



GDO-54



GDR-112

## Door Clutch Kits

S.E.E.S. #	O.E.M. #	Description
<b>GDO-59</b>	CLU3-0006L, CLU9-000L	<b>Door Clutch Kit</b> , LWZ-2 with 10" Link, L.H., with HW
<b>GDO-59A</b>	CLU3-0006R, CLU9-000R	<b>Door Clutch Kit</b> , LWZ-2 with 10" Link, R.H., with HW
<b>GDO-59B</b>	CLU9-0002L	<b>Door Clutch Kit</b> , LWZ-2 with 6" Link, L.H., with HW
<b>GDO-59C</b>	CLU9-0004L	<b>Door Clutch Kit</b> , LWZ-2 with 12" Link, L.H., with HW
<b>GDO-59D</b>	CLU9-0003L	<b>Door Clutch Kit</b> , LWZ-2 with 8" Link, L.H., with HW
<b>GDO-59E</b>	CLU9-0002R	<b>Door Clutch Kit</b> , LWZ-2 with 6" Link, R.H., with HW
<b>GDO-59F</b>	CLU9-0003R	<b>Door Clutch Kit</b> , LWZ-2 with 8" Link, R.H., with HW
<b>GDO-59G</b>	CLU9-0004R	<b>Door Clutch Kit</b> , LWZ-2 with 12" Link, R.H. with HW
<b>GDO-59H</b>	CLU9-0013L	<b>Door Clutch Kit</b> , LWZ-2-LOW w/ 10" Link, with HW
<b>GDO-59I</b>	CLU9-0013R	<b>Door Clutch Kit</b> , LWZ-2-LOW w/ 10" Link, R.H., w/ HW
<b>GDO-59J</b>	CLU9-0014L	<b>Door Clutch Kit</b> , LWZ-2-LOW w/ 6" Link, L.H., w/ HW
<b>GDO-59K</b>	CLU9-0014R	<b>Door Clutch Kit</b> , LWZ-2-LOW w/ 6" Link, R.H., w/ HW
<b>GDO-59L</b>	CLU9-0015L	<b>Door Clutch Kit</b> , LWZ-2-LOW w/ 8" Link, L.H., w/ HW
<b>GDO-59M</b>	CLU9-0015R	<b>Door Clutch Kit</b> , LWZ-2-LOW w/ 8" Link, R.H., w/ HW
<b>GDO-59N</b>	CLU9-0016L	<b>Door Clutch Kit</b> , LWZ-2-LOW w/ 12" Link, L.H., w/ HW
<b>GDO-59P</b>	CLU9-0016R	<b>Door Clutch Kit</b> , LWZ-2-LOW w/ 12" Link, R.H., w/ HW
<b>GDO-80</b>	CLU16-0003L	<b>Clutch</b> , CWZ-2 with roller & lock cable with door mounting plate, left
<b>GDO-80A</b>	CLU17-0005R	<b>Clutch</b> , C-2 with Sheave Mntg Plate Cable R.H.
<b>GDO-80B</b>	CLU17-0005L	<b>Clutch</b> , C-2 with Sheave Mntg Plate Cable L.H.
<b>GDO-80R</b>	CLU16-0001R	<b>Clutch</b> , CWZ-2 with Roller & Lock Cable Right
<b>GDO-80L</b>	CLU16-0001L	<b>Clutch</b> , CWZ-2 with Roller & Lock Cable Left
<b>GDO-81</b>	CLU15-0008N	<b>Clutch</b> , L-2 12" Link, SS 45-48 D.O. 2SP 45-56 D.O. 3SP 55-59 D.O.
<b>GDO-81R</b>	CLU16-0003R	<b>Clutch</b> , CWZ-2 with roller and lock cable, with door mounting plate, right
<b>GDO-86A</b>	HH2-0176L	<b>Mechanical Interconnecting Dev Set A2</b> , with 1/2" Mounting Bolts, Left
<b>GDO-87A</b>	HH2-0176R	<b>Mechanical Interconnecting Dev Set A2</b> , with 1/2" Mounting Bolts, Right

GDO-59 - GDO-59G

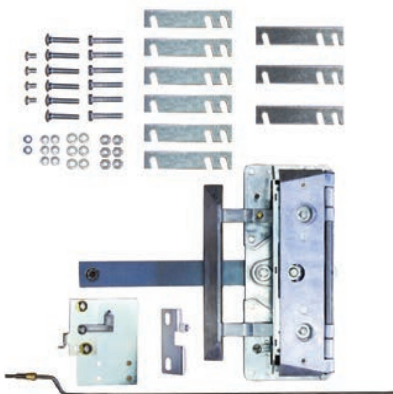

\* LWZ-2 Clutches come with hardware and restrictor parts.

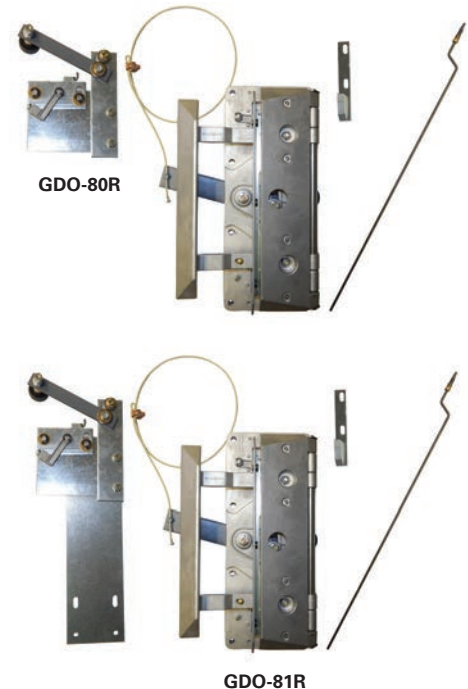
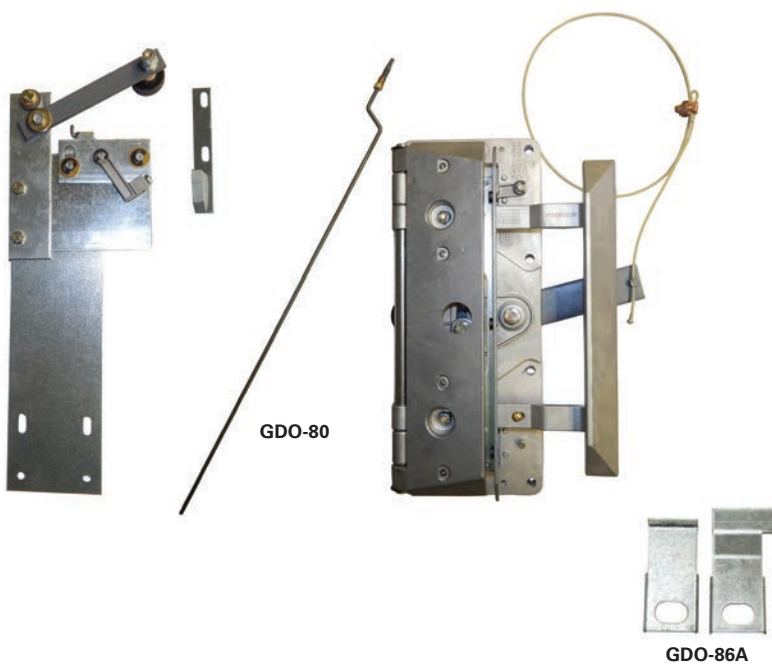



# Door Parts and Equipment

## Clutch and Restrictor Parts

S.E.E.S. #	O.E.M. #	Description
GDO-63	CLU9-0045N	Hardware, Clutch Mounting LW2/LW2-LRC STD/LWZ-2/LWZ-2-LRC
GDO-63A	CLU9-0046N	Hardware, Clutch Mounting, LW2-LOW/LW2-LRC LOW/LWZ-2-LOW/LWZ-2-LRC
GDO-64L	CLU9-0049L	Cam, LWZ-2 Standard Locking L.H., includes Hardware
GDO-64R	CLU9-0049R	Cam, LWZ-2 Standard Locking R.H., includes Hardware
GDO-69	CLU9-0111N	Cam, Clutch Actuating LW2/LWZ2 LW2-LOW & LWZ-2-LOW
GDO-69L	CLU9-0238L	Cam, L.H. Clutch Actuating For LW-2-LRC/LWZ-2-LRC
GDO-69R	CLU9-0238R	Cam, R.H. Clutch Actuating For LW-2-LRC/LWZ-2-LRC
GDO-66L	CLU9-0101L	Guide, Clutch Locking L.H. LWZ-2
GDO-66R	CLU9-0101R	Guide, Clutch Locking R.H. LWZ-2
GDO-67	CLU9-0103N	Vane, Clutch Rear Assembly LWZ-2-HA
GDO-68	CLU9-0108N	Rod, 36" Clutch Zone Locking LWZ-2
GDO-68A	CLU9-0094N	Rod, 24" Clutch Zone Locking LWZ-2

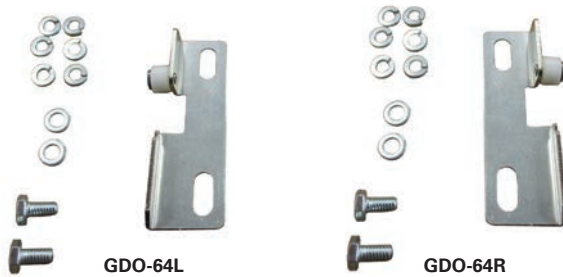
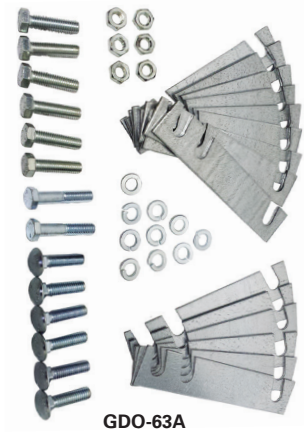

GAL

## Door Parts and Equipment

### Clutch and Restrictor Parts

S.E.E.S. #	O.E.M. #	Description
<b>GDO-70</b>	CLU9-0113N	<b>Roller</b> , 1-1/4" Dia. Used On LWZ-2/LZ-2 Clutch
<b>GDO-70A</b>	SPG-0019N	<b>Spring</b> , 7/8" LG x .250" O.D. for LW2-LWZ-2 Clutches
<b>GDO-70B</b>	SPG-0036N	<b>Spring</b> , Conical 1-1/4" x 3/4" O.D. for LW2-LWZ-2 Clutches
<b>GDO-71L</b>	CLU9-0114L	<b>Locking Assy</b> , LWZ-2 Clutch L.H. 36" Rod with California Cam
<b>GDO-71R</b>	CLU9-0114R	<b>Locking Assy</b> , LWZ-2 Clutch R.H. 36" Rod with California Cam
<b>GDO-73</b>	CLU9-0116N	<b>Vane</b> , Door Close for LWZ-2/LW-2 Clutch
<b>GDO-74</b>	CLU9-0255N	<b>Sensing Bar &amp; Pivot</b> , LW-2 Zone Lock W/2, 1-9/32" L Pins
<b>GDO-75</b>	CLU9-0256N	<b>Arm</b> , LWZ-2 Retracting Assy Rep For Jobs After 07-31-2006
<b>GDO-76L</b>	CLU9-0257L	<b>Vane</b> , LWZ-2 L.H. Door Open
<b>GDO-76R</b>	CLU9-0257R	<b>Vane</b> , LWZ-2 R.H. Door Open
<b>GDO-77</b>	SHF-0065N	<b>Shaft</b> , 7/16" x 11-7/8" LG LWZ2 Open Vane 11-1/2" Headless



GDO-70



GDO-70A



GDO-70B



GDO-73



GDO-74



GDO-75



GDO-76L



GDO-76R



GDO-77

## Motors

S.E.E.S. #	O.E.M. #	Description
GCB-01	MTR-00018N SET	<b>Brush</b> , FHP HRG.25 x .375 x 1.06 for GDO-24 Original GAL Motor
GCB-02	63913688	<b>Brush</b> , FHP-234 .25 x .50x 1.13 for GDO-24 SEES AOS Motor
GDO-24	MTR-0008N	<b>Operator Motor</b> , 1/6 HP, 230 VDC, 1140 RPM, shunt wound, does not come with pulley
GDO-24A	HWPL-00-1N	<b>Pulley</b> , 2" O.D. for 5/8" shaft, for motor GDO-24 and GDO-24B
GDO-24B	MTR-0009N	<b>Operator Motor</b> , 1/4 HP, 230 VDC, 1140 RPM, shunt wound, does not come with pulley
GDO-24D	MTR-0008N-PM	<b>Motor</b> , Door Operator, 1/6 HP, 1140 RPM, 230 VDC, MOD Type, permanent magnet
GDO-24DA		<b>Shaft Pulley</b> , 1-3/8" x 1/2"
GDO-24E	MTR-0011N	<b>Door Motor</b> , PM, 115 VDC, 1/6 HP, 1140 RPM MOD
GDO-24F	MTR-0010N	<b>Door Motor</b> , 1/2 HP 230 VDC PM (MOH OPP), 1140 RPM
GDO-24H	MTR-0021N	<b>Door Motor</b> , 1/2 HP 230 VAC 3Ph, 60 Hz, 1140 RPM (MOVFR operator)
GDO-24J	MTR-0023N	<b>Door Motor</b> , 1/2 HP 208-230/460V, 3Ph, 1724/1425 RPM Water Resistant



GDO-24



GDO-24A



GDO-24B



GCB-01



GCB-02

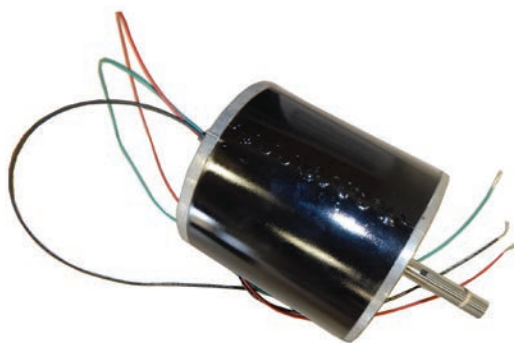

GDO-24D



GDO-24E



GDO-24F



GDO-24H



GDO-24DA



GDO-24J

# Car Signal Components

## Key Switches

S.E.E.S. #	O.E.M. #	Marking/Description
GKS-2	KS3-0059H	Fire Service Key Switch, PH II, Horizontal, car (1617 key)
GKS-2V	KS3-0059V	Fire Service Key Switch, PH II, Vertical, Remove All (1617 key)
GKS-2R	KS3-0088-H	Fire Service Key Switch, PH II, Horizontal, Remove 2 Pos (1617 key)
GKS-2RV	KS3-0088V	Fire Service Key Switch, Fire OP, PH II, RKR 3 Pos (1617 key)
GKS-3	KS3-00584, KS3-0057H	Fire Service Key Switch, PH I, Horizontal, Hall (1617 key)
GKS-3V	KS3-0057V	Fire Service Key Switch, PH I, Vertical, (1617 key)
GKS-4	KS1-0112H	Key Switch, round, Independent Service, Hall, (1601 key)
GKS-4V	KS1-0112V	Key Switch, round, Independent Service, Key #G1601X Vertical
GKS-5	KS1-0101H	Key Switch, round, OFF/ON Horizontal (1601 key)
GKS-6	KS1-0101V	Key Switch, round, OFF-ON vertical, removable both positions (1601 key)
GKS-7	KS1-0141H	Key Switch, Stop/Run horizontal (1601 key)
GKS-7V	KS1-0141V	Key Switch, Stop/Run, vertical (1601 key)
GKS-7R	KS1-0141H	Key Switch, Run/Stop, Red Round, Horizontal (1601 key)
GKS-7RV	KS1-0141V	Key Switch, Run/Stop, Red Round, Vertical (1601 key)
GKS-8	KS1-0096V	Key Switch, "ACCESS DN-OFF-UP", Vertical, round, black, (1612 key)
GKS-8H		Key Switch, 3pos Access Dn-Off-Up, Horizontal, black (1612 Key)
GKS-9	KS3-0087H	Fire Service Key Switch, PHI, "RESET-OFF-ON", horizontal (1617 key)
GKS-9A	KS3-0087V	Fire Service Key Switch, PHI, vertical "RESET-OFF-ON" (1617 key)
GKS-SPECIAL		Key Switch, Specify Markings, Positions, Key pull and Key number



## Key Switches

S.E.E.S. #	O.E.M. #	Marking/Description
GKS-10H	KS1-0093H	<b>Key Switch</b> , Horizontal RKB Blank 2 Position Momentary 1 Remove (1613 key)
GKS-10V	KS1-0093V	<b>Key Switch</b> , Vertical RKB Blank 2 Position Momentary 1 Remove (1613 key)
GKS-11H	KS3-0097H	<b>Key Switch</b> , Horizontal RKR, 3P-R3, 1-AUTO-2-EMERG PWR, (1617 key)
GKS-11V	KS3-0097V	<b>Key Switch</b> , Vertical RKR, 3P-R3, 1-AUTO-2-EMERG PWR, (1617 key)
GKS-12V	KS3-0001V	<b>Key Switch</b> , Vertical RKR, 2P-R2, NORM, FIRE SERV, (2642 key)
GKS-12H	KS3-0001H	<b>Key Switch</b> , Horizontal RKR, 2P-R2, NORM, FIRE SERV, (2642 key)
GKS-13V		<b>Key Switch</b> , Vertical, 2P-R2 Off-On-Access, USE #2
GKS-13H		<b>Key Switch</b> , Horizontal, 2P-R2 Off-On-Access Round Black
GKS-14V		<b>Key Switch</b> , Vertical, 3P-Sprg Ret Cntr, UP Off-Down-Access, Black, Round, USE #2
GKS-15H	KS3-0005H	<b>Key Switch</b> , 3 POS, 2KP, Norm. Hold-Fire-Svc, Key 2642
GKS-16H	KS3-0005H	<b>Key Switch</b> , Horizontal, 2 POS, 2R, Off On Light, Key 1601
GKS-17H	KS1-0107H	<b>Key Switch</b> , Horizontal, 2 POS, 2R, Off On Fan, Key 1601
GKS-18H-SPECIAL		<b>Key Switch</b> , Horizontal, 2 POS, 2R, Off On, Special Marking, Key 1601
HAZ-KS-001	XCS-0K2A1-KLRK	<b>Key Switch</b> , 2 Position, Hazardous Areas
HAZ-KS-002	XCS-0S2A1-KLRK	<b>Selector Cover Switch</b> , Hazardous Areas
KAZ-KS-002	XCS-0S2A1-KLRK	<b>Selector Cover Switch</b> , 2 Positions, Hazardous Areas



GKS-10H



GKS-10V



GKS-11H



GKS-11V



GKS-12H



GKS-13V



GKS-14V



GKS-17H



GK-1

GK-2

## Keys

S.E.E.S. #	O.E.M. #	Marking/Description
GK-1	G1612X	<b>Key</b> , 1612, for access or inspection
GK-2	G1613, KEY-0069N	<b>Key</b> , 1613, for spring return switches
GK-200	KEY-0063N	<b>Key</b> , Medeco "LF" Code
GK-201	KEY-0064N	<b>Key</b> , Medeco "FS" Code
GKS-1	G1601X, KEY-0067N	<b>Key</b> , 1601 Key
GKS-2A	G1617, KEY-0070N	<b>Key</b> , 1617 Key, Fire Service



GK-200



GK-201



GKS-1



GKS-2A

## Car Signal Components



GB-1B-1

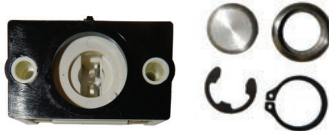

GB-100

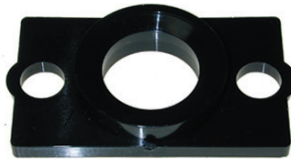

GB-1C



GB-1-ARROW



GB-1A-GREEN ARROW



ML-117



GDO-20A



GDO-20B



GDO-21

### Pushbutton Module

S.E.E.S. #	O.E.M. #	Description
GB-1B-	PB1-	<b>Pushbutton Module</b> , button assembly complete, 2 N.O. contacts, 120v. Black halo/mounting plate with white illuminated button with black marking. Button cap 7/8" dia., halo 1-3/8" O.D., mounting holes 2" center to center. Vertical or horizontal mount. Specify marking, i.e. <b>GB-1B-1</b>
GB-1B-EMERGE-POWER		<b>Pushbutton Assembly Complete</b> , "Emergency Power" Indicator
GB-1B-HOSP-SERV		<b>Pushbutton Assembly Complete</b> , "Hospital Service" Indicator
GB-1B-SEISMIC		<b>Pushbutton Assembly Complete</b> , "Seismic" Indicator
GB-100	PB3-0007N	<b>Pushbutton</b> , VPMC11 2 N.O. Non-Illuminated SS 1/8 Cover
GB2-0137	PB2-0137N	<b>Pushbutton</b> , GAL, VPW 120V S.S Marked "Arrow" 2 N.O. Incandescent

### Pushbutton Caps

S.E.E.S. #	O.E.M. #	Description
GB-1-	PB-1	<b>Pushbutton Cap</b> , white button with black marking, for pushbutton assembly. Button cap 7/8" diameter. Specify marking, i.e. <b>GB-1-ARROW</b>
GB-1C	PMDG-0066N	<b>Halo</b> , black, for pushbutton
GB-1D	PMDG-0067N	<b>Halo</b> , white, for RRB Push Button

### Position Indicator Inserts

S.E.E.S. #	O.E.M. #	Description
GB-1A-	SFP-	<b>Position Indicator Insert</b> , white, round insert 1-1/8" dia. with black marking, specify marking, i.e. <b>GB-1A-GREEN ARROW</b>
ML-117		<b>Neon Lamp Assembly</b> , single, 120V neon "electric plug" style

### Emergency Stop Switch Assembly

S.E.E.S. #	O.E.M. #	Description
GDO-20A	PB4-0001H	<b>Pull to Stop</b> , Emergency Stop Switch Module, collar is marked "PULL TO STOP/PUSH TO RUN". Eliminates accidental switch actuation.
GDO-20B	PB4-0020H	<b>Stop Switch</b> , Pull-Stop/Push-Run 2 N.O. - 1 N.C. Flat Insert-Muntz Cap
GDO-21	6073F4	<b>Toggle Style</b> , Emergency Stop Switch, 1 N.O., 1 N.C. PB6-0005V contacts. For vertical mount. Round, black insert/collar with red toggle and red markings "RUN" and "STOP" symbols

## Car Signal Components

### Emergency Stop Switch Assembly

S.E.E.S. #	O.E.M. #	Description
GDO-20	PB4-0011H	<b>Push to Stop</b> , Emergency Stop Switch Module, horizontal mount, 1 N.O., 2 N.C. (2 N.C. / 1 N.O. In Run Position) contacts. Round, black insert/collar with red button marked "STOP", collar marked "PUSH TO STOP/PULL TO RUN"
GDO-78	PB4-0019H	<b>Pull-Stop/Push-Run button</b> , VP 2 N.C. - 1 N.O., stainless steel



GDO-20



GDO-78

### Limit Switches

S.E.E.S. #	O.E.M. #	Description
GDO-83	OP10-0004R	<b>Switch Assembly</b> , MOD Limit control, R.H.
GDO-90	OP10-0004L	<b>Switch Assembly</b> , MOD Limit control, L.H.
GDO-31	OP10-0005R	<b>Contact Base Assembly</b> , R.H. includes contact base and 3/8" silver contact screw 3/4" long, 12 required
GDO-31A	OP10-0005L	<b>Switch Assembly, Contact Base Assembly</b> , L.H. includes contact base and 3/8" silver contact screw 3/4" long, 12 required
GDO-301L	OP10-0001L	<b>Switch Assy</b> , Limit Control, 230V MOD with #35 Chain L.H.
GDO-301R	OP10-0001R	<b>Switch Assy</b> , Limit Control, 230V MOD with #35 Chain R.H.
GHE-200	SW5-0001N	<b>Limit Switch</b> , Type "LS" 1 N.C.
GLS-001	SW16-0001N	<b>Switch</b> , LD Limit, 2 N.C. Contacts
GLS-002	SW5-00020N	<b>Switch</b> , "LSO" Limit, 1 N.O. Contact
GLS-003	SW4-0002N	<b>Switch</b> , "LTD" Limit, 1 N.O. / 1 N.C. Contact
GLS-004	SW4-0001N	<b>Switch</b> , "LTS" Limit, 1 N.O. Contact
GLS-005	SW5-0003N	<b>Switch</b> , "LS" Limit, 1 N.C. Contact, Manual Reset



GHE-200

GLS-004



GDO-83



GDO-90

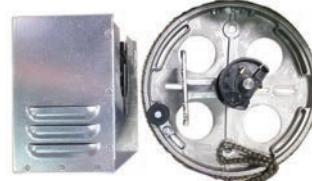

GDO-301L



GLS-001

### Emergency Equipment

S.E.E.S. #	O.E.M. #	Description
GB-100	PB3-0007N	<b>Push Button</b> , VPMC11 2 N.O. non-illuminated SS 1/8 Cover
GB-200	PMDG-0136N	<b>Emergency Light Lens</b> , white molded plastic, 6-1/2" x 3-1/4" replacement lens for GB-201
GB-201	EMER-0001N, EL-2, EL-4	<b>Emergency Light Assembly</b> , with battery MIS-194I
GB-201A	EMER-0007N, EL4NL	<b>Emergency Light Assembly</b> , New Version No Lights or Sockets
GB-201B	EMER-0034N	<b>Emergency Light</b> , with LED Board
GB-201C	EMER-0067N	<b>PCB</b> , LED for Emergency Light
GB-201E	EMER-0068AN	<b>Emergency Light</b> , with LED Board, EL-5
GB-202	SW19-0003N, ML-10	<b>Emergency Exit Switch</b> , TOC button with keyswitch CTE-3 Lamp, 6.3, Watts 1.575, Bulb T-3-1/4, Mini Bayonet, M.O.L. 1.19
MIS-194Q	BAT-0003N	<b>Battery</b> , 6V, 4.6 AMP, 2.76" x 1.87" x 4.25"
MIS-194I	BAT-001N	<b>Battery</b> , 4.8V, 4.0 AH, 3-3/4" L x 2-1/2" H 5 D cells stacked 2 on 3. - See page 270.
MIS-194J		<b>Battery</b> , E Light 6V 10AH 6L-3.7, 5H-2W
MIS-194Q	BAT-0003N	<b>Battery</b> , 6V, 4.6 AMP, 2.76" x 1.87" x 4.25"



GB-200



GB-202



GB-201



GB-201C



MIS-194I



MIS-194J

## Printed Circuit Boards

S.E.E.S. #	O.E.M. #	Description
GPC-001	MOVFR-0001N	PCB, Main Door, Operator MOVFR Input PCBs Not Included
GPC-002	MOVFR-0002N	Auxiliary Input PCB for door operator
GPC-004	MOCT-0004L	PCB, MOCT enhanced without relays and fuses, L
GPC-005	MOCT-0004R	PCB, MOCT enhanced without relays and fuses, R
GPC-007	MOVFR-0070N	PCB, MOVFR II & MOVFRW II Main PC with (3) Input PCBs
GPC-008	MOVFR-0070N	Interface, PCB, MOD
GPC-009	DPPC-0001N	Chip, Door Protection Enabling
GPC-200	MOVFR-0072N	Drive, MOVFR II Operator Frequency 230 VAC, Includes Drive Ribbon Cable
GPC-203	MOVFR-0070N	PCB, MOVFR II & MOVFRW II MAIN PC w/ (3) Input PC Boards (W/4)
GPC-203A	MOVFR-0070N	PCB, MOVFR II & MOVFRW II MAIN PC w/out Input PC Boards (W/4)
GPC-204	GALX-1064AN	PCB, Traction Main I/O Revised
GPC-205	ECIA045.00012348	MOVFR 3.0 LCD Board Kit
GPC-206	2500-3050	PCB/Drive MOVFE, 230 VAC
G-TOOL-003	2500-3051	Parameter Tool, for MOVFE
GBPC-1	LED-00062	PCB, LED Red PB
GPC-207		MOVFR I to MOVFR II Conversion Kit, 115V
GPC-208		MOVFR I to MOVFR II Conversion Kit, 230V
GPC-209	MOVFR-0102N	MOVFR-0102N Board Kit, 230V



GPC-001



GPC-002



GPC-004

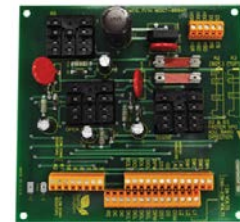

GPC-005



GPC-007



GPC-008



GPC-009



GPC-200



GPC-203

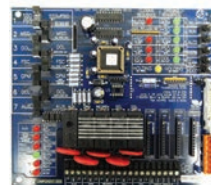

GPC-203A



## GPC-205

### Features & Benefits

The GPC-205 offers the very latest in door control technology, including advancements in power management providing for longer service life. State of the art design includes no removable modules or relays, eliminating intermittent failures and unnecessary field service labor.

The new design simplifies parameter adjustments and diagnostics through the on-board LCD display, while eliminating the need of a hand held tool. The main control board and elevator specific variable frequency drive greatly reduces field set-up labor.

- Identical foot print application, fit, form and function, for replacing MOVFR I & MOVFR II
- On-board LCD display - parameter adjustment in real time “no hand-held tool required for parameter adjustment”.
- User friendly LCD rotation - work from either side of the operator.
- On-board LED function indicators.
- Job specific variable frequency drive board - advanced design reduces heat for superior drive efficiency.
- Universal input voltage - no plug-in modules required, reducing maintenance cost.
- Door detector enabled through LCD display - no chip purchase required.
- Control board contains no antiquated removable modules or relays, utilizing current state of the art components, further reducing wasted field service labor.

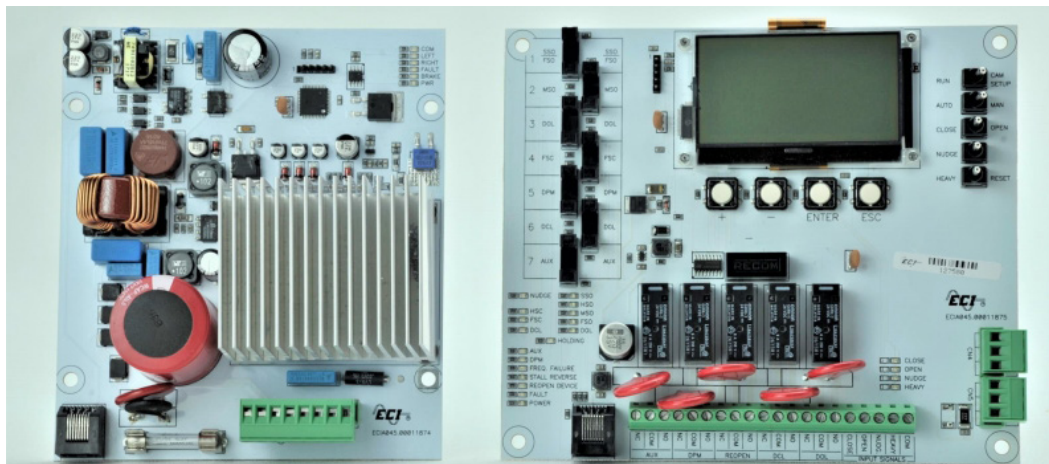

VARIABLE FREQUENCY DRIVE

LOGIC CONTROL BOARD

## Timers

S.E.E.S. #	O.E.M. #	Description
GT-1	0A4G	<b>Electronic Tube</b> for Tube Type Timers #10041
GT-2	TMR-0001N, 10121-1, 10121-3	<b>Solid State Timer</b> , Replacement for Single and Double Potentiometers, .01 to 640 sec. Replaces tube type timers #10041-1, #10041-2, #10041-3 and #10041-4
GT-2A	TMR-0008N	<b>Hardware Kit only</b> , for GT-2 Timer
GT-2B		<b>Kit</b> , GT-2 and GT-2A Timer with Hardware



GT-1

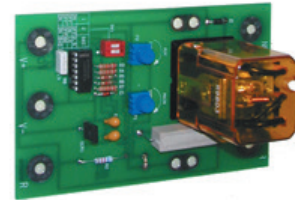

GT-2

## Coils

S.E.E.S. #	O.E.M. #	Description	I.D.	O.D.	C/C	STYLE
GC-1	5632	<b>Coil</b> , 265 VDC	7/8	1-3/4	2-1/4	A
GC-2	5693	<b>Coil</b> , 208/220 VAC	7/8	1-3/4	2-1/4	A
GC-3	5631	<b>Coil</b> , 230 VDC	15/16	2-1/4	2-5/8	A
GC-4	5630	<b>Coil</b> , 265 VDC	1-1/8	2-13/16	3-5/16	B
GC-5	5785	<b>Coil</b> , 230 VDC	1-1/16	2-3/8	3	B
GC-6	6437	<b>Coil</b> , 265 VDC	1-1/8	1-7/16		C
GC-7	5744	<b>Coil</b> , 230 VDC	3/4	1-3/4	2-1/4	A
GC-8	5761	<b>Coil</b> , 1.4 Ohm	1-3/16	2-13/16	3-1/4	B
GC-9	6439	<b>Coil</b> , 85 VDC	5/8	1-7/16		C
GC-10	6438	<b>Coil</b> , 230 VDC	5/8	1-7/16	7/8	C
GC-11	6202	<b>Coil</b> , 130 VDC	1-3/16	2-13/16		B
GC-12	6779N	<b>Coil</b> , 265 VDC	1-1/5	2-1/5		D



GT-2A



GC-10

GC-11

GC-12



GDO-304



GDO-304A

GDO-305

## Contacts

S.E.E.S. #	O.E.M. #	Description
GDO-304	INT22-0020N	<b>Contact Kit</b> , "N"/"SN" Interlock Lower
GDO-304A	INT22-0019N	<b>Contact Kit</b> , "N"/"HNA" Interlock Upper
GDO-305	INT8-0008N	<b>Cover</b> , SMD Lock & Contact
GRP-1	LC-0029L, LC-25-#8	<b>Movable Contact</b> , Left Hand
GRP-2	LC-25-#7, LC-0029R	<b>Movable Contact</b> , Right Hand
GRP-3	CONT-0002N, LC-16-#22	<b>Stationary Contact</b> , Silver 3/8", 3/4" thread length, 15/16" O.L.
GRP-3A	LC-26-#9, CONT-0002N	<b>Stationary Contact</b> , Silver 3/8", 3/8" thread length, 9/16" O.L.



GRP-2



GRP-3



GRP-3A

## Contacts

S.E.E.S. #	O.E.M. #	Description
GRP-4	CONT-0001N, LC-16-#23	<b>Stationary Contact</b> , Carbon 3/8", 3/4" thread length, 1-1/4" O.L.
GRP-5	LC-16-18, LC-0003N	<b>Main contact holder</b> , 3/8"
GRP-6	LC-0016N	<b>Copper Contact</b> , 1-3/4" dia. x 3/8" thick with 1" stem
GRP-7	LC-0015N	<b>Copper Contact</b> , 1-1/2" dia. x 5/16" thick with 1" stem
GRP-8	LC-0018N	<b>Copper Contact</b> , 1" diameter x 5/16" thick with 1" stem
GRP-9	CONT-0009N	<b>Carbon Contact</b> , 1-3/4" dia. x 1"
GRP-9A	LC-0041N	<b>Holder</b> for Carbon Contact 1-3/4" diameter, thread 1/2-13
GRP-9B	LC-0041N	<b>Supporting Stud</b> for GRP-9A, 1/2-13 Female w/ 3/8-16 Stud
GRP-9S	LC-0097N	<b>Supporting Stud</b> for GRP-9A holder
GRP-10	CONT-0008N	<b>Carbon Contact</b> , 1-1/2" dia. x 7/8"
GRP-10A	LC-0083N	<b>Holder</b> for Carbon Contact 1-1/2" diameter, thread 3/8-16
GRP-11	CONT-006N	<b>Carbon Contact</b> , 1" diameter x 3/4"
GRP-11A	LC-0042N	<b>Holder</b> for Carbon Contact 1" dia., thread 5/16
GRP-11S	LC24.1-47, LC-0098N	<b>Supporting Stud</b> for GRP-11A holder
GRP-14	LC-7.1-12A	<b>N.C. Contact Post assembly</b> , 2-3/4"
GRP-18	LC-7.1-18A, LC-0090N	<b>N.O. Contact Post assembly</b> , 3-1/4"
GRP-19	LC-7.1-50A, LC-0095N	<b>Supporting Stud</b> for GRP-10A holder
GRP-38	LC-28-8, LC-0085N	<b>N.O. Contact Post assembly</b> , 1-7/8"
GRP-39	LC-28-9, LC-0084N	<b>N.O. Contact Post assembly</b> , 1-7/16"
GRP-40	LC-28-10, LC-0082N	<b>N.C. Contact Post assembly</b> , 1-5/8"
GRP-44	INT3-0010N	<b>Contact</b> , MOW/MOX bridging Yellow Zinc
GRP-45	INT5-0015N	<b>Contact kit</b> , M interlock lower
GRP-47	LC-0090N	<b>Post</b> , 3-1/4", LG contact



GRP-4



GRP-5



GRP-6



GRP-7



GRP-8

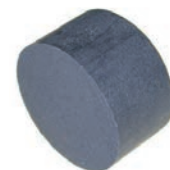

GRP-9



GRP-9A



GRP-9S



GRP-14



GRP-18



GRP-19



GRP-40



GRP-44

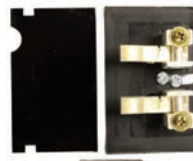

GRP-45



GRP-47

## Relay Parts



GRP-13

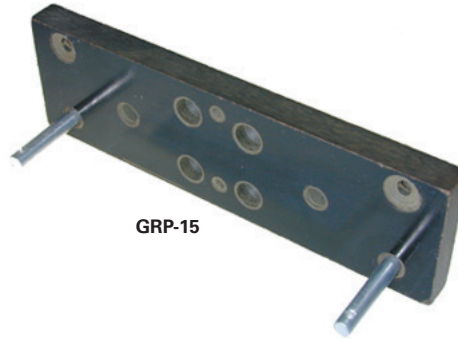

GRP-15



GRP-16



GRP-32A

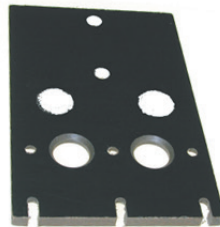

GRP-36

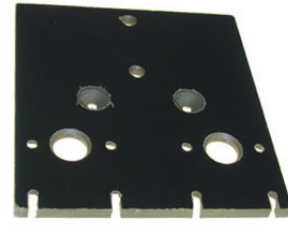

GRP-37



GRP-33

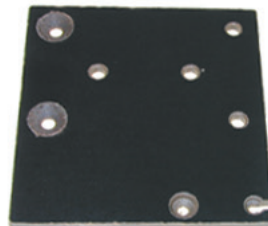

GRP-34

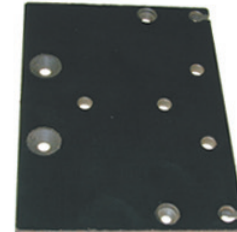

GRP-35

## Contact Plates

S.E.E.S. #	O.E.M. #	Description
GRP-13	LC-7.1-9, LC-0075N	Plate for Auxiliary Contact, N.C.
GRP-15	LC-7.1-13, LC-0059N	Plate 1 for Main Contact
GRP-16	LC-7.1-14, LC-0076N	Plate 2 for Auxiliary Contact, N.O.
GRP-32A	LC-25#2, LC-0078N	Contact Plate
GRP-33	LC-28-2, LC-0056N	Contact Plate, (2) Main, (0) Auxiliary
GRP-34	LC-28-3, LC-0057N	N.O. Contact Plate, (2) Main, (1) Auxiliary
GRP-35	LC-28-4, LC-0058N	N.O. Contact Plate, (2) Main, (2) Auxiliary
GRP-36	LC-28-5, LC-0078N	N.C. Contact Plate, (3) Contacts
GRP-37	LC-28-6, LC-0076N	N.C. Contact Plate, (4) Contacts

## Relay Parts

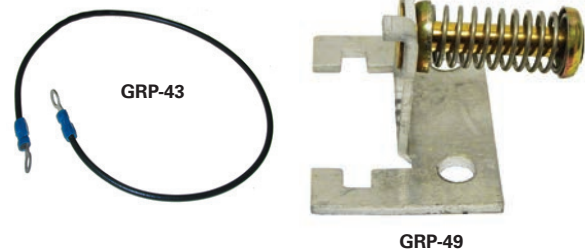
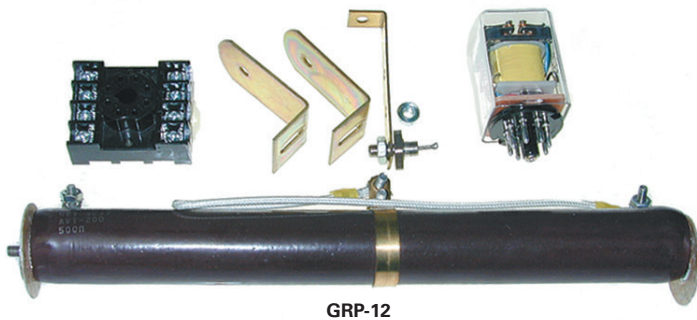

S.E.E.S. #	O.E.M. #	Description
GRP-12	250-30, LC56-0001N	Relay, replacement kit to replace Ward Leonard "CC" or "HC"
GRP-20	LC-7.1-55, LC-0014N	Flexible Connector, #8 Wire, 13-1/4"
GRP-22	LC-8.1-60, LC-0105N	Knurled Rivet, F.H. 1/4" x 1-1/2"
GRP-23	LC-8.1-62	Compression Spring
GRP-24	LC-8.1-63	Spring Washer
GRP-25	LC-8.1-64	Cotter Pin
GRP-26	LC-8.1-65, LC-0014N	Flexible Connector, #8 Wire, 15-1/4"
GRP-28	LC-23.1-21	Rivet, F.H. 3/16" x 1-1/4"
GRP-29	LC-23.1-52	Compression Spring
GRP-30	LC-23.1-53	Spring Washer
GRP-31	LC-23.1-54	Cotter Pin
GRP-41	LC-28-11	Terminal Stud Assembly
GRP-42	LC-28-17, LC-0104N	Main Contact Spring Assembly
GRP-43	LC-28-20, LC-0011N	Flexible Connector, #14 Wire, 13-1/2"
GRP-49	LC-0137N	Bracket & Spring, Kick Off for Relays LC28, LC49, & LC49P
GRP-200	LC-0105N	Spring Assembly, 7/8", 1-1/2" for Main Contacts
RES-59	974435	Resistor, Adjustable, 250 OHM 20 OW

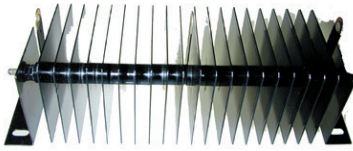

GR-1



GS-1

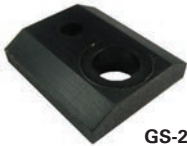

GS-2



GS-2A



GS-3

S.E.E.S. #	O.E.M. #	Description
GR-1	C44S10D1H11G, DIOD-0019N	<b>Doubler</b> , 20 plates, 2" x 4"
GR-2	C11S10D1H11G	<b>Doubler</b> , 20 plates, 1.3" x 1.3"

S.E.E.S. #	O.E.M. #	Description
GS-1	SEL-0086N	<b>Selector contact brush</b> , with spring and nuts
GS-2	SEL-0001N	<b>Selector segment holder</b> for #3
GS-2A		<b>Selector Segment</b> , Bottom Half for #3
GS-2B	SEL-0023N	<b>Selector Holder Assembly</b> Segment (GS-2 & GS-2A)
GS-3	GALX-0307N	<b>Tape Guide</b> , for GAL Selector

## Guide Rollers

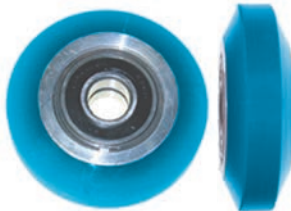

GW-1

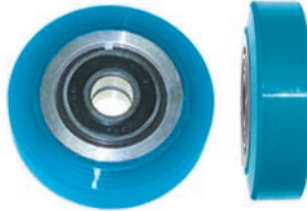

GW-1A

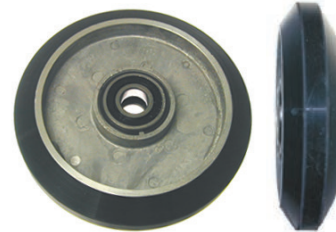

GW-2



GW-2A



GW-3

S.E.E.S. #	O.E.M. #	Description
GW-1	377-12	<b>Roller Guide Wheel</b> , 3-1/4" O.D. with 1/2" face, 2 bearings, .6693" I.D.
GW-1A	377-13	<b>Roller Guide Wheel</b> , 3-1/4" O.D. with 3/4" face, 2 bearings, .6693" I.D.
GW-2	378-12	<b>Roller Guide Wheel</b> , 6" O.D. with 1/2" face, 2 bearings, .6693" I.D.
GW-2A	378-13	<b>Roller Guide Wheel</b> , 6" O.D. with 3/4" face, 2 bearings, .6693" I.D.
GW-3	SW1-0007N	<b>Roller and Bolt</b> , Roller 1.25" O.D. x 1/2" W, Bolt 1.40" L x .43" W, for gate switch
HWW-001	377-14	<b>Roller Guide Wheel</b> , Hollister Whitney, 3-1/4" diameter face roller, .420" face
HWW-001A	377-15	<b>Replacement Wheel</b> , 3-1/4" Dia. Hollister Whitney side roller, .665" face, for HWRG-001
HWW-002	378-14	<b>Roller Guide Wheel</b> , Hollister Whitney, 6" diameter face roller, .430" face
HWW-002A	378-15	<b>Roller Guide Wheel</b> , Hollister Whitney, 6" diameter side roller, .865" face
HWMP-001		<b>Eyebolt Slotted Plunger</b> , #92 Disc Brake
HWMP-002		<b>Eyebolt Housing</b> , #92 Disc Brake
HWMP-003	207-092	<b>Solenoid</b> , Remote Trip Pin
HWMP-004	207-087	<b>Solenoid Assembly</b> , Resettable Governor
HWMP-63		<b>Split Seal Kit</b> , Hollister, 63 Machine



HWW-001



HWW-001A



HWW-002



HWW-002A